

No. B28443 01004

I N S T R U C T I O N M A N U A L

D I E S E L G E N E R A T O R

Before using, be sure to read this manual for the sake of safety.

**Be sure to observe the items under symbol marks "⚠ WARNING"
and "⚠ CAUTION" for the sake of safety.**

Always keep this manual at your machine for the sake of safety.

D C A - 3 5 S P K



HEAD OFFICE

2-8-5 Nihonbashi-horidomecho, Chuo-ku, Tokyo, 103-0012 Japan

TEL +81 - 3 - 6861 - 1111

FAX +81 - 3 - 6861 - 1181

FOREWORD

- * Your machine is a portable type diesel generating set.
- * Do not install, operate or repair this machine without reading this operating manual.
- * This generator set (machine) must be operated by a person having sufficient knowledge and skill for the sake of safety.

Notes on instruction manual

- * This instruction manual explains correct operation and maintenance of the machine to ensure its performance.
Incorrect handling of the machine may lead to a serious injury or decease.
Before using, be sure to read this manual carefully.
Particularly, the items under " Safety precautions",
"⚠ WARNING" and "⚠ CAUTION" must be read thoroughly.
- * Keep this manual in the case behind the rear or side door for future reference.
- * Read the contents of the warranty card attached to the machine.
- If this manual becomes illegible by spot or damage, contact distributor or our office to get new manual.

- Contents -

1. Safety Precautions	----- 1
2. Construction	----- 8
2-1 Outline and parts names	----- 8
2-2 Operating panel, control panel and parts names	----- 10
2-3 Meters	----- 11
2-4 Use of switches and controllers	----- 14
3. Transportation and installation	----- 16
3-1 Transportation of machine	----- 16
3-2 Installation of machine	----- 16
4. Connecting the load	----- 18
4-1 Cables to be used	----- 18
4-2 Connecting the load	----- 19
4-3 Grounding	----- 21
5. Operation	----- 22
5-1 Checking prior to operation	----- 22
5-2 Startup	----- 26
5-3 Handling during operation	----- 28
5-4 Shutdown	----- 29
5-5 Protection device	----- 30
6. Lubrication, cooling water and fuel	----- 31
6-1 Engine oil	----- 31
6-2 Cooling water	----- 31
6-3 Fuel	----- 31
7. Handling of battery	----- 32
7-1 Caution on battery charge	----- 33
7-2 Connection of booster cable, and installation	----- 34
8. Periodical checking and maintenance	----- 35
8-1 Maintenance schedule	----- 37
8-2 Checking/first 50 hours	----- 38
8-3 Checking/every 100 hours	----- 39
8-4 Checking/every 250 hours	----- 39
8-5 Checking/every 500 hours	----- 41
8-6 Checking/every 1000 hours	----- 42
8-7 Table of periodical maintenance and checking	----- 43
9. Troubleshooting	----- 44
10. Long-term storage	----- 46
11. Service data	----- 47
11-1 Service data	----- 47
11-2 AC generator specification (for custom voltage)	----- 48
11-3 Outline drawing	----- 49
11-4 Generator connection diagram	----- 50
11-5 Engine wiring diagram	----- 51
12. Options instruction manual	----- 52
12-1 Earth leakage relay	----- 52

1. Safety Precautions

In order to ensure safe operation, the following symbols are used for explanation of the machine operation.

The following symbols, found throughout this manual, alert you to potentially dangerous conditions to the operator, service personnel, or the equipment.

△ WARNING:

This symbol refers to a hazard or unsafe practice which can result in severe personal injury or death.

△ CAUTION:

This symbol refers to a hazard or unsafe practice which can result in personal injury or product or property damage.

[Note] :

This symbols show handling precautions for effective operation and many years of satisfactory operation.

Some of the items shown by "△ CAUTION" may also cause death or serious injury. Be sure to observe all the items, as they are important for safe operation.

- * If the machine is used by an outsider, you are requested to explain him correct handling and advise him to read this instruction manual carefully.
- * Do not modify the machine at your discretion, as it affects the safety, performance or the life of the machine.
- * If the machine is modified or it is used incorrectly against this manual or unauthorized parts are used, the warranty of manufacturer will become invalid.

Safety label

Safety labels are attached to the following positions of the machine.

- * Keep these safety labels clean at all times.
- * When safety labels are spoiled or lost, contact distributor or our office specifying the nameplate No. shown below and ask for new ones.

No.	Parts name	Parts number	No.	Parts name	Parts number
1	Safety instruction	B9211 0040	6	Warning:moving part	B9040 0040
2	Warning:exhaust gas	B9042 0000	7	Warning:fire accident	B9045 0000
3	Warning:output voltage	B9311 0050	8	Caution:high temp	B9040 0030
4	Warning:electric leakage	B9111 0040	9	Warning:radiator cap	B9041 0010
5	Warning:electrical shock	B9311 0060	10	Warning:interior wiring	B9111 0030

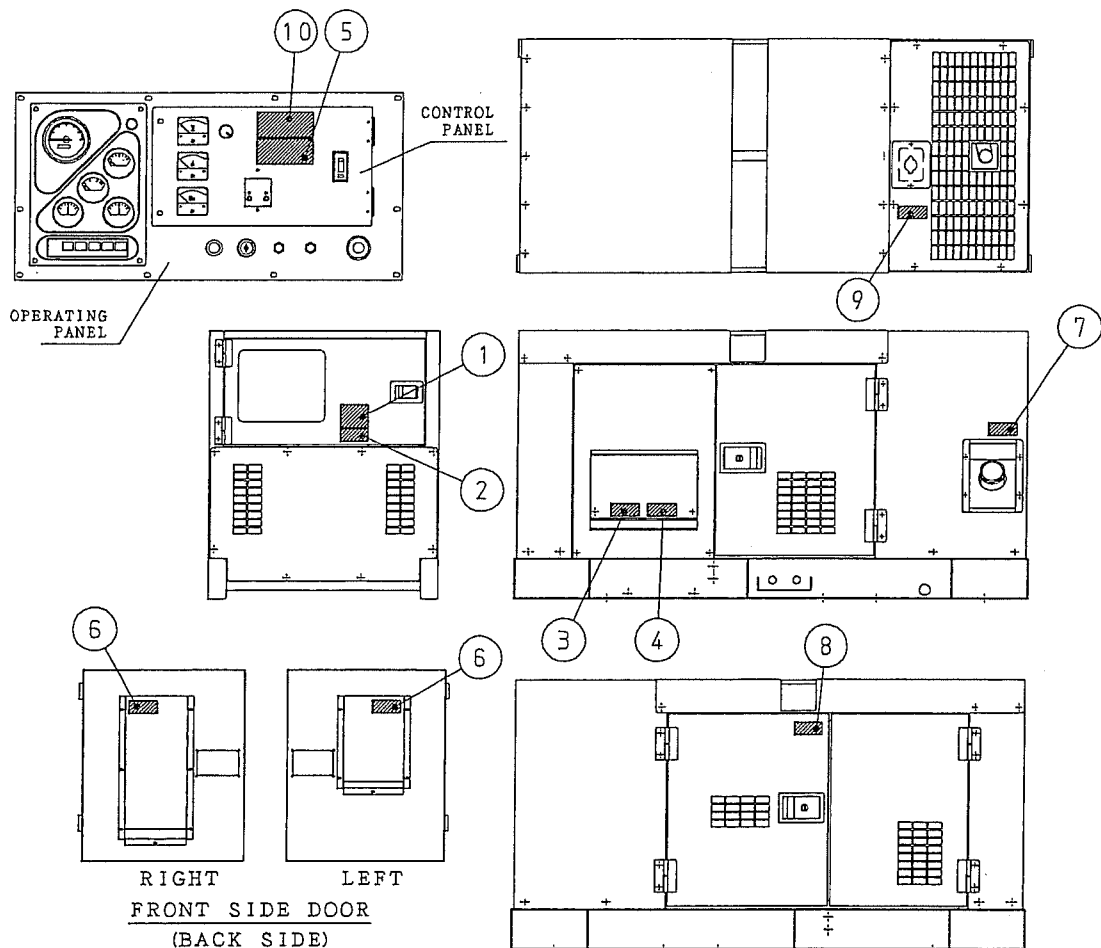

⚠ WARNING

ENGINE EXHAUST can kill.

■ Insufficient ventilation may lead to death due to lack of oxygen or poisoning by exhaust gases.

- * Do not use the machine in a place of poor ventilation or in a place where exhaust gases stays.
- * Do not use the machine indoors or in storehouse, tunnel, ship hold, tank, etc. of poor ventilation.
- * If it becomes necessary to use the machine in the above places, the exhaust pipe should be extended to a well ventilated place. In this case, use a ventilator to ensure proper ventilation.
- * Do not direct the exhaust outlet to nearby pedestrians and houses.

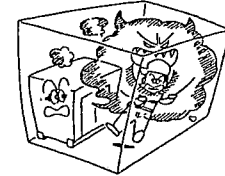
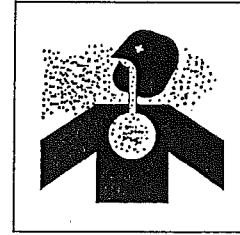

⚠ WARNING

ELECTRIC SHOCK can kill.

■ Do not touch the output terminals during operation to prevent decease due to electric shock.

- * Never touch the output terminals during operation. If your hands or the machine are wet, it will result in a death or serious injury.
- * When a wiring work is required, be sure to turn OFF the circuit breaker and stop the machine.
- * Keep the output terminal cover closed and the terminal bolts tightened while the machine is running.
- * A low voltage is generated even when the machine is in low speed idle operation. Be sure to stop the machine completely.

■ Do not touch the electrical parts in the machine during operation, as it may lead to death due to electric shock.

- * Always close the control panel and tighten the fixing bolts before operating the machine.
- * Always close the side door and lock it before operating the machine.
- * When opening the control panel for voltage selection, etc., turn OFF the circuit breaker and stop the machine.

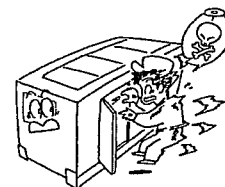
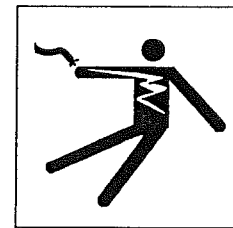

⚠ WARNING

ELECTRIC SHOCK by leak can kill.

■ Improper grounding may lead to death due to electric shock.

* Be sure to execute the grounding of the machine and the load according to the local rule.



⚠ WARNING

MOVING PARTS can cause severe injury.

■ Rotary unit which runs at a high speed is located in the machine. (Note that it is very dangerous if you touch it.)

- * Be sure to close the door and lock it during operation.
- * When the door needs to be opened during operation, do not get your hands and head in the machine to prevent them from being caught in the machine which may lead to injury.
- * When making check or maintenance of the machine, be sure to stop the machine in advance.

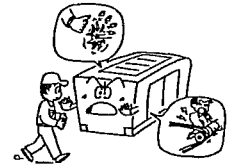
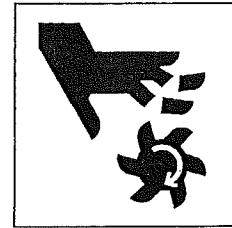

⚠ WARNING

DIESEL FUEL can cause fire or explosion.

■ Fuel and oil are flammable. Incorrect handling results in danger of ignition or fire.

- * When fuel needs to be supplied to the machine, be sure to stop the engine. Refrain from smoking.
Keep the machine away from fire.
- * Do not leave flammable objects (paper, wood chips, etc.) and hazardous objects (oil, powder, etc.) near the machine.
- * Wipe off spilt fuel and oil.

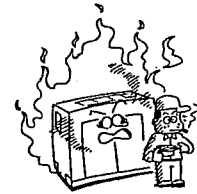
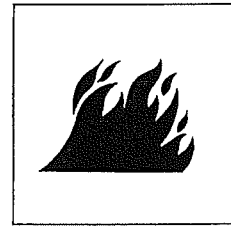

⚠ WARNING

HOT COOLANT can cause severe scalds.

■ If the radiator cap is opened while the water temperature is high, steam or hot water will spout out.

- * During operation or immediately after stopping the machine, do not open the radiator cap while the water temperature is high.
- * When cooling water needs to be checked or supplied, wait until the engine is cooled (50°C or less as measured with the water temperature gauge).

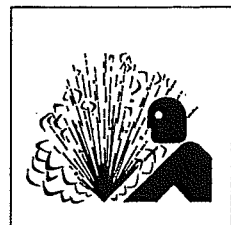

⚠ CAUTION

Stacking

■ Improper stacking of machines may cause falling or dropping accidents. When stacking other machines on this machine, be sure to observe the following points.

- * Check that the bonnet of the machine is free from damage and that the fixing bolts are not loosened and missing.
- * Put the machine horizontally on a solid foundation which withstands the weight of stacked machines.
- * Machines can be stacked up to 2 stages. The weight and size of stacked machines should be less than those of this machine.
- * Using square timbers as shown right, put each machine making sure that the weight is even.

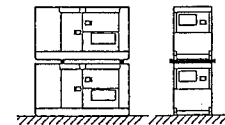

■ Do not operate the machines in the state of stacking to prevent falling or dropping accidents.

⚠ CAUTION

HOT PARTS can burn skin.

■ High temperature units are located in the machine.
(Note that these units are very dangerous if they are used incorrectly.)

- * Be sure to close the door and lock it during operation.
- * If the door needs to be opened during operation, do not get your hands and head in the machine to prevent unexpected burns.
- * When making check or maintenance of the machine, be sure to stop the machine.
- * The bonnet is still hot even after the machine is stopped. Be careful until the engine is completely cooled.

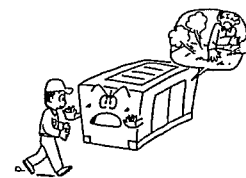
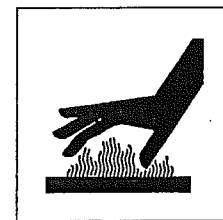

⚠ CAUTION

Battery

■ Battery generates flammable gases. Improper handling may lead to explosion or serious injury.

* Battery should be charged in a well ventilated location. Otherwise, flammable gases are accumulated which may be ignited and exploded.

* When connecting a booster cable, do not jumper the terminals (+ and -). Otherwise, the flammable gases generated from the battery may be ignited and exploded by sparks.

* For maintenance of the machine, disconnect the ground cable on the ground side.

■ The battery acid is dilute sulfuric acid. Improper handling will cause unexpected burns.

* When the battery acid gets on your clothes or skin, wash it out with a large volume of water immediately. If it gets in your eyes, wash with a large volume of water immediately and consult your doctor.

- In the worst case, it will put out your eyes.

■ For checking or handling of the battery, be sure to stop the engine and turn OFF the battery switch in advance.

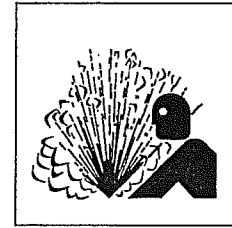

⚠ CAUTION

Operator

■ Do not operate the machine if operator is tired too much or drinks some alcohol or take some drugs.

* Otherwise, it may cause unexpected accidents or injury.

■ During checking or maintenance, be sure to put on suitable clothes and protectors.

* Do not put on baggy clothes, necklace, etc., because they are easily caught by projections which may cause injuries.

⚠ CAUTION

Noise

■ This machine generates large noise if the door is open. Surrounding to large noise may cause hearing trouble.

* Close and lock the door during operation.

* If opening the door is necessary during operation, be sure to put on the ear protector.

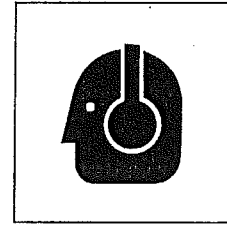

⚠ CAUTION

Connection to house wiring

■ Before connecting this machine to any building's electrical system, a licensed electrician must install an isolation(transfer) switch.

* Serious injury or death may result without this transfer switch.

⚠ CAUTION

Transportation

■ Do not lift the machine at the support hook or the ladder because it is not strong enough for lifting and may cause a falling accident.

* When lifting the machine, use the hanger located at the roof center.

* Keep out under the lifted machine.

■ Do not lift or do not transport the machine during operation, as it may cause damage to the fan or serious trouble.

* When loading the machine on the truck or the like, fix the machine firmly by support hooks on the both side.

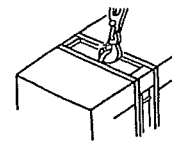

2. Construction

2-1 Outline and parts names

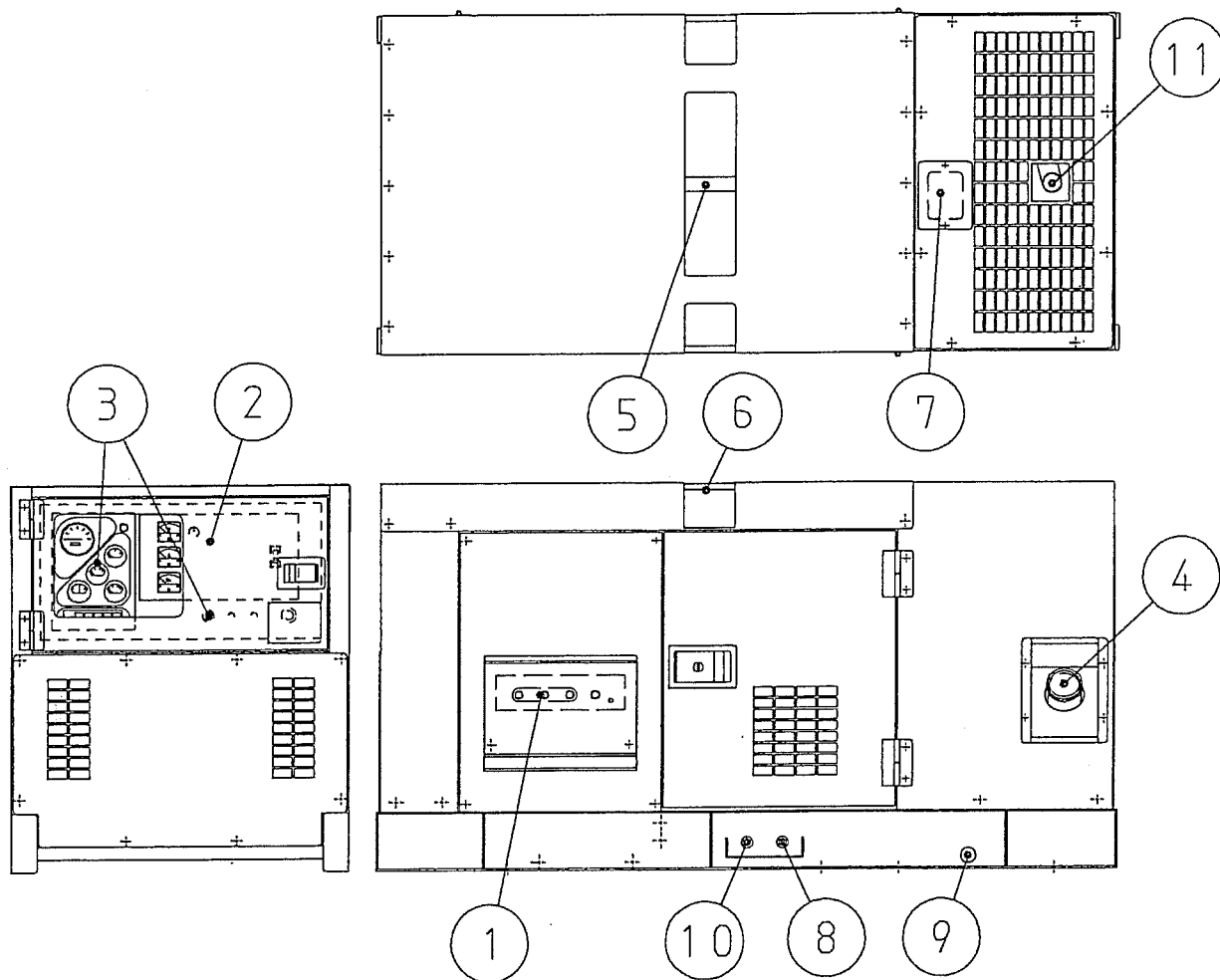

- 1. OUTPUT TERMINAL
- 2. CONTROL PANEL
- 3. OPERATING PANEL
- 4. FUEL IN
- 5. HANGER ROD
- 6. SUPPORT HOOK

- 7. COOLANT IN
- 8. COOLANT DRAIN PLUG
- 9. FUEL DRAIN PLUG
- 10. OIL DRAIN PLUG
- 11. EXHAUST GAS OUTLET

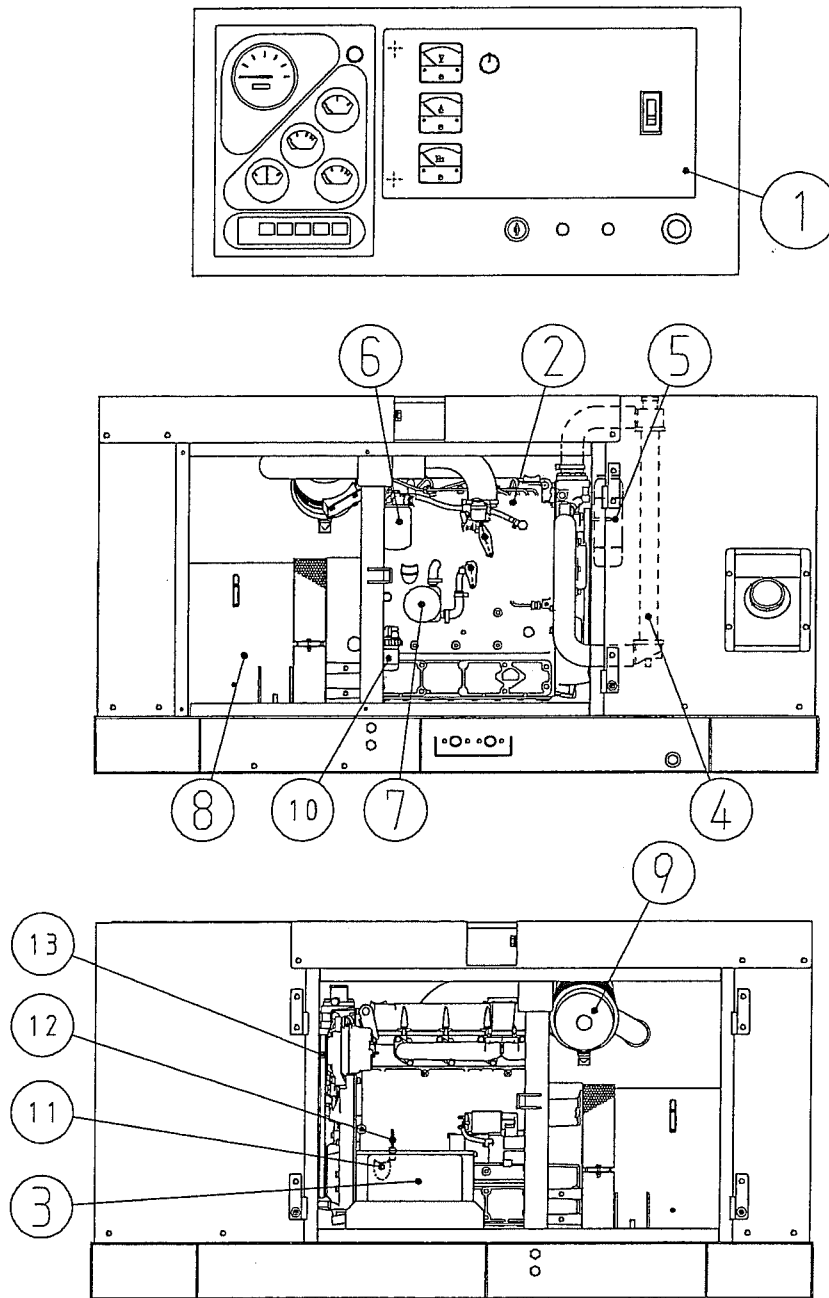

- | | |
|-------------------------|---------------------|
| 1. CONTROL PANEL | 8. AC GENERATOR |
| 2. DIESEL ENGINE | 9. AIR CLEANER |
| 3. BATTERY | 10. WATER SEPARATOR |
| 4. RADIATOR | 11. ENGINE OIL IN |
| 5. COOLANT RESERVE TANK | 12. DIPSTICK |
| 6. FUEL FILTER | 13. FAN BELT |
| 7. OIL FILTER | |

2-2 Operating panel, control panel and parts names

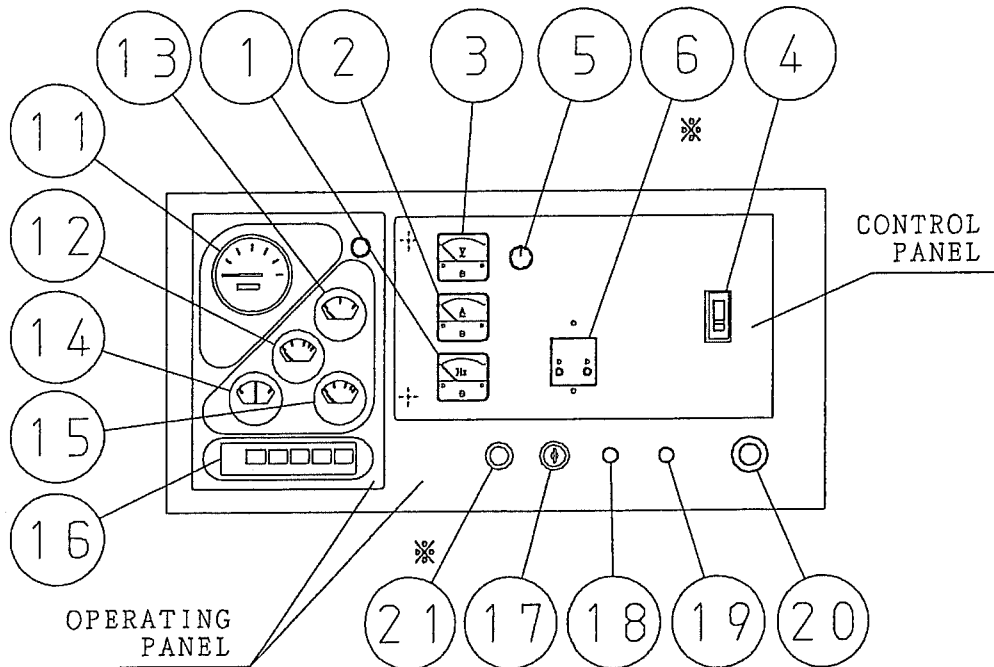

CONTROL PANEL (※OPTION)

- 1. FREQUENCY METER
- 2. AC AMMETER
- 3. AC VOLTMETER
- 4. CIRCUIT BREAKER
- 5. VOLTAGE REGULATOR
- 6. EARTH LEAKAGE RELAY ※

OPERATING PANEL (※OPTION)

- 11. TACHOMETER
- INTEGRATING TIME METER
- 12. OIL PRESSURE GAUGE
- 13. WATER TEMP. GAUGE
- 14. CHARGING AMMETER
- 15. FUEL GAUGE
- 16. WARNING LAMP UNIT
- 17. STARTER SWITCH
- 18. PREHEAT LAMP
- 19. CHARGING LAMP
- 20. THROTTLE HANDLE
- 21. EMERGENCY STOP BUTTON ※

2-3 Meters

Engine indicators

(1) Tachometer (0-3000rpm)

This meter indicates the number of revolutions (per minute) of the engine.

It indicates 1500rpm at 50Hz or 1800rpm at 60Hz.

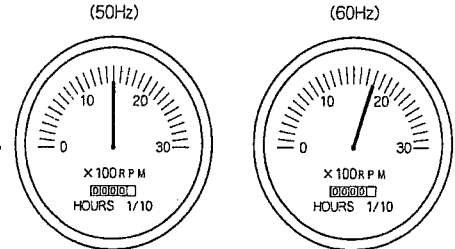

(2) Time meter

This meter indicates the total running time of the engine.



(3) Oil pressure gauge

This meter indicates the engine oil pressure. It is normal when it indicates $3\sim 5 \times 100\text{kPa}$ during operation.

If the engine is cool, it may indicate higher values at the time of startup. Put the engine in warming up operation and wait until oil pressure becomes normal.

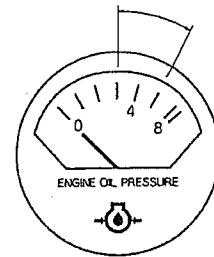

(4) Water temperature gauge

This meter indicates the engine cooling water temperature. It is normal when it indicates 75 to 105°C during operation.

[Note] :

If it indicates higher values, turn OFF the load and set the machine in cooling operation by setting the throttle handle to the "START/IDLING" position, and wait until the temperature lowers.

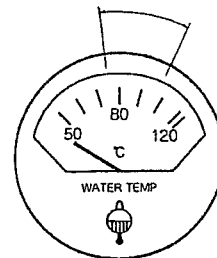

(5) Charging ammeter

This meter indicates the current supplied by the alternator to batteries.

It is normal when it indicates the range of 0 or +.

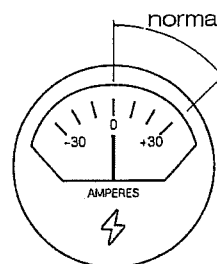

(5) Fuel gauge

This gauge indicates amount of fuel in tank.

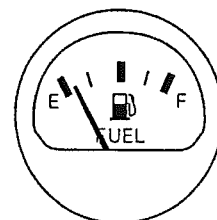

Generator indicators

(1) Frequency meter

This meter indicates frequency of the output voltage. Make sure that it indicates 50Hz or 60Hz during operation.

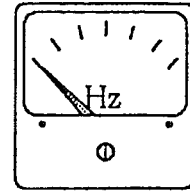

(2) AC ammeter

This meter indicates AC current flowing into the connected load. Make sure that it is always pointing below the rated current.

When running the three phase and single phase loads together, this meter indicates total current of them.

When running either the three phases or single phase load, this meter indicates the current flowing into the load.

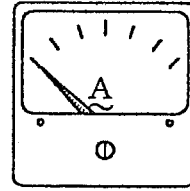

(3) AC voltmeter

This meter indicates AC output voltage. Make sure that it indicates rated voltage.

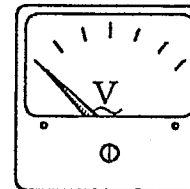

Indication/alarm lamp

(1) Preheat lamp

When the starter switch is set in the "PREHEAT" position, this lamp goes on.

In a little time this lamp goes off, indicating that the machine has been preheated to be ready for startup.



(2) Charging lamp

This lamp goes on when the output voltage of the alternator drops unusual value.

If this lamp goes on during operation, the emergency stop device immediately operates to shutdown the engine automatically.

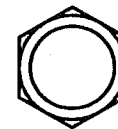

(3) Warning Lamp

This monitor indicates the following failures, if any one of them occurs.

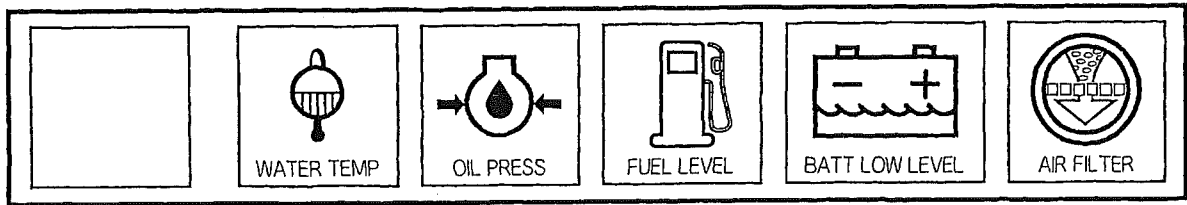

① High jacket water temperature (WATER TEMP)

This lamp goes on when the water temperature rises abnormally. If the lamp goes on during operation, the emergency stop device immediately operates to shut down the engine automatically.

「5-1.(2) Check on engine cooling water See p.23」

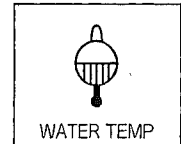

② Oil pressure failure (OIL PRESS)

If the machine is in normal operation, this lamp stays off. When the starter switch is turned to "RUN" position to start the engine, the lamp goes on, and when the oil pressure rises after startup, it goes off. If this lamp goes on during operation, the emergency stop device immediately operates to shutdown the engine automatically.

「5-1.(1) Checking on engine oil See p.23」

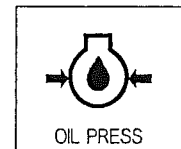

③ Fuel level failure (FUEL LEVEL)

When fuel is running low, this lamp goes on, and it should be supplied at the tank.

「5-1.(4) Check on fuel See p.24」

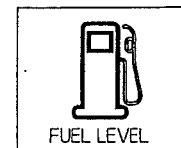

④ Battery acid level failure (BATT LOW LEVEL)

When battery acid is running low, this lamp goes on, and distilled water should be supplied to the battery.

「5-1.(5) Check on battery acid See p.24」

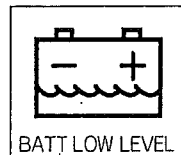

⑤ Air filter blinding (AIR FILTER)

When the air element is blinded, this lamp goes on. Indicating that the element should be immediately cleaned or replaced.

「8-3.(1) Cleaning of air cleaner element See p.39」

「8-6.(2) Replacement of air cleaner element See p.42」

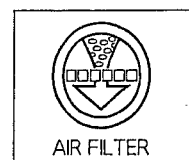

2-4 Use of switches and controllers

Switches

(1) Starter switch

Functions:

① Stop

This switch should be set in this position unless the machine is in operation. The key can be inserted or pulled out in this position.

② Run

This switch should be set in this position when the machine is in operation.

③ Start

This is the position to start the engine. When your hand is released from the key after starting, it is automatically set in the position of "RUN".

④ Preheat

This is the position to start the engine when the air temperature is low. Set the switch in this position until the preheat lamp goes off, and then set it in the start position.

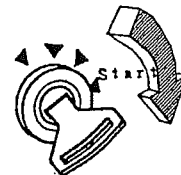
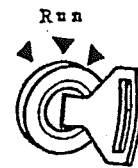

(2) Speed control device

• Throttle handle

- * In order to unlock the handle, the bottom of the throttle handle should be turned counterclockwise (ie RELEASE).
- * Pressing the center button on the throttle handle, pull the handle out slowly and fully, to increase the speed and set it to cross the no-load speed.
- * Fine speed control can be done by adjusting the throttle handle. Turn the throttle handle clockwise to decrease engine speed and counterclockwise to increase engine speed.
- * After adjusting machine to its desired engine speed and load, the bottom of the throttle handle should be turned clockwise (ie HOLD) to lock the handle at the required speed and load.
- * In order to set the machine to idling speed, unlock the throttle handle down slowly and fully to decrease the engine speed to idling.

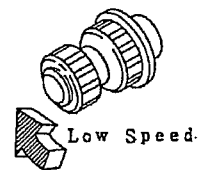

- Adjust the idling speed

Adjust the engine set the idling speed with the throttle handle to the no-load engine speed specified below.

As the handle has been fixed by the lock ①, release the handle by turning to the RELEASE side.

Pushing the button ③, pull the knob ② to increase the engine speed, and pushing the button ③, push the knob ② to decrease the engine speed. After that, turn the knob ② for fine adjustment.

Lock the throttle handle by turning the lock ① to the HOLD side after setting the engine speed at the specified speed.

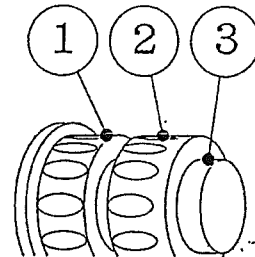

	Frequency (Idling speed)
Operation at 50 Hz	52.5 Hz (1575 rpm)
Operation at 60 Hz	62.5 Hz (1875 rpm)

If the idling speed set above speed, frequency becomes nearly 50Hz or 60Hz in the rated load.

(3) Circuit breaker

This is a main switch to supply power to a load. When the load is shorted or in the state of overload, it trips to protect the generator against trouble.

[Note] :

Do not use this circuit breaker to turn ON/OFF the load, to prevent damage to the circuit breaker.

When it trips with over-current, the handle of the breaker stops between ON and OFF positions. This is what is called the trip condition.

In this case, push the handle down to the OFF position to reset it, or else, it cannot be set in ON position.

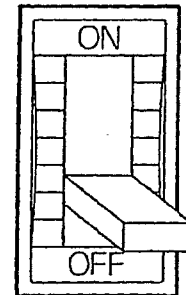

Voltage regulator and over-current relay

(1) Voltage regulator

This regulator is used to control the output voltage. Turn the regulator to clockwise to increase the voltage and counter-clockwise to decrease it. Adjust the voltage to the rated voltage with this regulator.

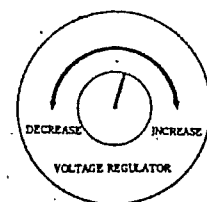

(2) Over-current relay

This relay is used to trip the circuit breaker (for 3-phase) when over-current flows into the circuit.

If the circuit breaker (for 3-phase) trips and cannot be closed, stop the engine and open the control panel. Then, press the reset button.

[Note] :

Do not change the set value unnecessarily.

RESET BUTTON

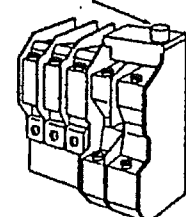

3. Transportation and installation

3-1 Transportation of machine

△ CAUTION

Transportation

■ Do not lift the machine at the support hook or the ladder because it is not strong enough for lifting and may cause a falling accident.

* When lifting the machine, use the hanger located at the roof center.

* Keep out under the lifted machine.

■ Do not lift or do not transport the machine during operation, as it may cause damage to the fan or serious trouble.

* When loading the machine on the truck or the like, fix the machine firmly by support hooks on the both side. The detail as machine size is referred to

「11-1. Specifications See p.47」

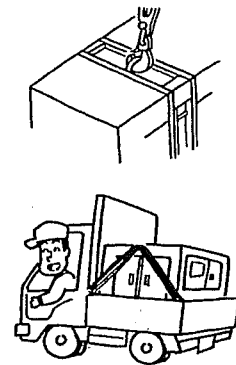

3-2 Installation of machine

△ WARNING

ENGINE EXHAUST can kill.

■ Insufficient ventilation may lead to death due to lack of oxygen or poisoning by exhaust gases.

* Do not use the machine in a place of poor ventilation or in a place where exhaust gases stays.

* Do not use the machine indoors or in storehouse, tunnel, ship hold, tank, etc. of poor ventilation.

* If it becomes necessary to use the machine in the above places, the exhaust pipe should be extended to a well ventilated place. In this case, use a ventilator to ensure proper ventilation.

* Do not direct the exhaust outlet to nearby pedestrians and houses.

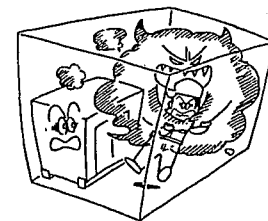
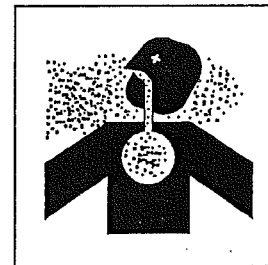

[Note] vibration:

The engine, running, generates vibration during operation of the machine.

When installing the machine, be sure to observe the following points.

- * Install the machine horizontally on a solid foundation. Operation on an uneven place will generate unusual vibration.
- * The machine should be installed on a substantial base to prevent claims from nearby living people. For details of the vibration level of the machine and foundation work, contact distributor or our office.

[Note] noise:

The engine is running during operation of the machine.

If the door is open, much noise will be generated. But some noise will stay, when door is closed.

When installing the machine, be sure to observe the following points.

- * Close and lock the door after installation.
- * We recommend to execute the measure for sound level to prevent claims from nearby living people.

Installation procedure

- * Install the machine horizontally on a solid foundation.
- * Provide a space of more than about 1m at the side of the control panel and fuel feed port to ensure correct operation and supply.
- * Provide a space of more than about 1.2m on the left and right sides for check of the engine, oil supply and cable connection work.
- * A sufficient space is required at the top of the machine to allow hot air (exhaust air) from the radiator and exhaust gases to be discharged and to supply water to the radiator.
- * When the machine is operated in a place with much dust or salt, careful maintenance is required to prevent clogging or damage to the radiator or poor insulation of electric parts.

Indoor installation

- * Exhaust gases should be discharged outdoors using an exhaust pipe.
- * Exhaust air should also be discharged outdoors using a duct or the like.
- * Insufficient indoor ventilation will raise the (indoor) temperature and affects the performance of the machine.
- * For details of required volume of ventilation, contact distributor or our office.

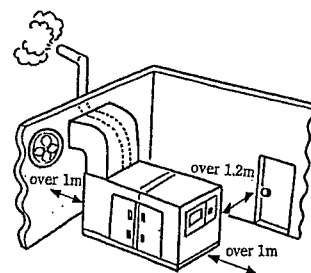

4. Connecting the load

4-1 Cables to be used

Selection of cables

Use cables having sufficient size in consideration of the allowable current of the cables and the distance between the machine and the load.

If the load current exceeds the allowable current of cables, the cable may be damaged by overheat. Also, if the cables are too small in size for the length, the input voltage of the load drops which lowers the working efficiency or causes failure in operation.

Select the length and size of cable so that the voltage drop "e" obtained by the following equation is within 5% of the rated voltage.

* Equation to obtain 3-phase, 3-wire system voltage drop "e" from the length and size of cable and operating current is as follows

$$e = \frac{1}{58} \times \frac{L}{S} \times I \times \sqrt{3}$$

where e: voltage drop (V) L: length (m)
S: cable thickness(mm²) I: load current (A)

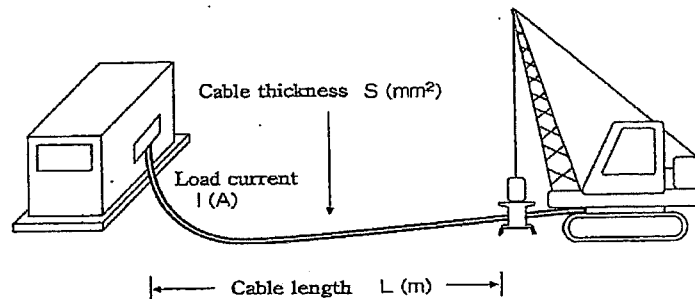

4-2 Connecting the load

⚠ WARNING

ELECTRIC SHOCK can kill.

■ Do not touch the output terminals during operation to prevent decease due to electric shock.

* When a wiring work is required, be sure to turn OFF the circuit breaker and stop the machine.

* When operating the engine, close the output terminal cover. Tighten the fixing bolts before operating the machine.

■ Do not use damaged cables to prevent electric shock. Insufficient tightening of bolts will generate heat at connections which may result in fire accidents.

* When connecting, make sure the connecting cables are normal and connected firmly to the output terminals.

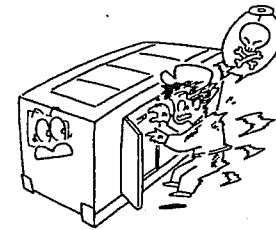
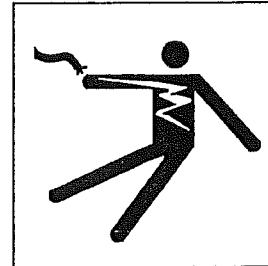

⚠ CAUTION

Connection to house wiring

■ Before connecting this machine to any building's electrical system, a licensed electrician must install an isolation (transfer) switch.

* Serious injury or death may result without this transfer switch.

(1) Fastening the output terminal

[Note] :

In connecting the load, tighten locking bolts securely with a spanner or the like to prevent burning.

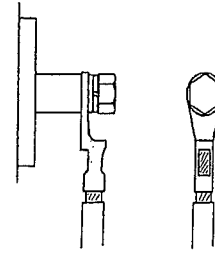

(2) Connecting three phase output terminal

Connect the load to the output terminal after confirmation of load phase and voltage.

Use U/V/W for three phase load

200/220V or 400/440V

(190V) (380V)

{415V}

[240V] [480V]

Use O/U,O/V,O/W for single phase load

115/127V or 231/254V

(110V) (219V)

{240V}

[139V] [277V]

Use U/V,V/W,W/U for single phase load

200/220V or 400/440V

(190V) (380V)

{415V}

[240V] [480V]

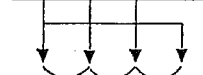
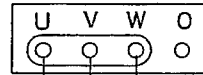
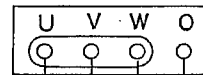
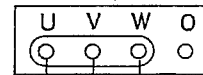
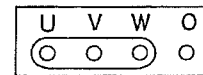

(3) Precaution in load connection

- ① Be sure to provide a switch for turning the load ON and OFF between the output terminal block and the load. Note that the use of the breaker of the machine for turning the load ON and OFF may result in breaker failure.
- ② In connecting the load, be sure to stop the engine and turn OFF the breakers on the control panel.
- ③ Don't contact the connecting cable to the output terminal of other phase.
- ④ When the load connection is finished, close the cover of output terminal and tighten by the bolts.

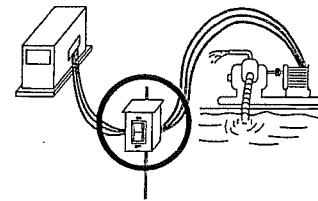

4-3 Grounding

⚠ WARNING

ELECTRIC SHOCK by leak can kill.

■ Improper grounding may lead to death due to electric shock.

* Be sure to execute the grounding of the machine and the load according to the local rule.

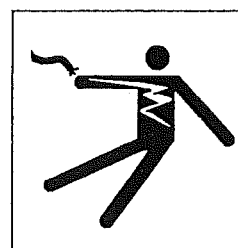

Grounding

Execute the grounding certainly to prevent the electric shock by leak.

(1) Case grounding of the machine

Use the grounding wire which sectional area conforms to the local rule.

Provide the grounding rod to satisfy the grounding resistance which conforms to the local rule.

(2) Case grounding of the load

Execute the grounding for the load similarly. Provide the grounding rod to satisfy the grounding resistance which conforms to the local rule.

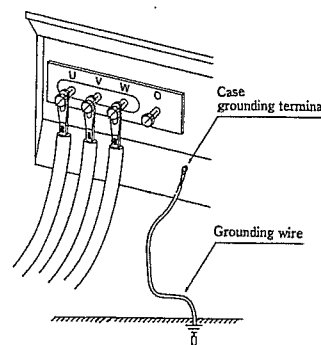

(3) Precaution in grounding

- ① Select a shady and highly moist place, and bury the grounding rod in such way that its top end is completely hidden in the ground.
- ② If burying the grounding rod on the place that many pedestrians walk on, clamp the lead wire to prevent catching on it.
- ③ If the lead wire is not long enough for the connection, connect it as directed below:
 - (1) Connect the lead wire and the extension wire by soldering or sleeve coupling securely and apply insulating tape to the connection.
 - (2) Do not bury the connection in the ground.
- ④ Avoid burying of grounding rod within 2m of grounding location for lightning conductor.
- ⑤ Do not use a telephone set grounding conductor.

5. Operation

— From pre-start check to shut down —

Be sure to check the machine prior to starting.

1. Pre-start check : Check oil, cooling water, fuel and so on.
2. Periodical check: Check each part of the machine according to operating time.
3. Startup: Check the surroundings of the machine for safe operation.

Use a sign before startup.

4. Operation: \triangle In the machine there are moving parts, high temperature parts and high voltage parts. Before operating, close the door and lock the side door for safe operation and for prevention of noise.

[Note] : If the warning lamp lights, stop the engine and check the cause of it.

[Note] : Check for leaks of oil, water, exhaust gases, and for unusual noise.

5. Shut down

5-1 Checking prior to operation

\triangle WARNING

MOVING PARTS can cause severe injury.

■ Rotary unit which runs at a high speed is located in the machine. (Note that it is very dangerous if you touch it.)

* Be sure to close the door and lock it during operation.

* When making check or maintenance of the machine, be sure to stop the machine in advance.

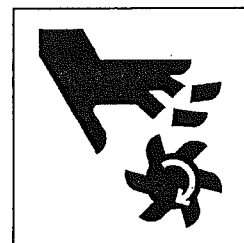

— To prevent unexpected trouble, be sure to check the following points.

- (1) Check on engine oil (lubricating oil)
- (2) Check on engine cooling water
- (3) Check on fan belt
- (4) Check on fuel
- (5) Check on battery acid
- (6) Check on grounding for electric shock protection
- (7) Check for leakage of oil and water
- (8) Check for loose parts
- (9) Removal of foreign objects in machine

Inspection

(1) Check on engine oil

(Read the instruction manual for the engine furnished separately.)

- ① Check the level of engine oil by the dipstick. Make sure the oil level is always between H and L.
- ② When it is below the low limit, supply oil immediately.
- ③ At the same time, check condition of oil by the dipstick.

[Note] :

Oil is consumed gradually during operation. When the machine is to be used continuously for a long time, be careful with lack of oil.

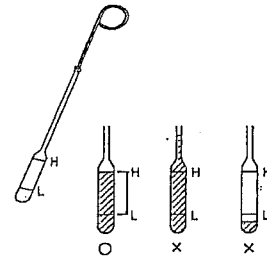

(2) Check on engine cooling water

(Read the instruction manual for the engine furnished separately.)

⚠ WARNING

HOT COOLANT can cause severe scalds.

■ If the radiator cap is opened while the water temperature is high, steam or hot water will spout out.

* During operation or immediately after stopping the machine, do not open the radiator cap while the water temperature is high.

* When cooling water needs to be checked or supplied, wait until the engine is cooled (50°C or less as measured with the water temperature gauge).

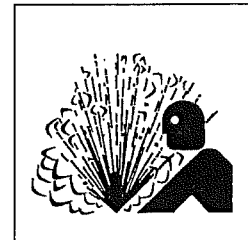

- ① Check (to see) that cooling water in the reserve tank is within the range of FULL-LOW.
- ② When it is below the low limit, supply (additional) water immediately.
- ③ Normally, only the water level of the reserve tank needs to be checked. But, the radiator cap should be opened once a week to check that water is full in the radiator.

[Note] :

When closing the radiator cap after water level is checked or water is supplied, turn the cap fully clockwise so that it can be firmly tightened.

Otherwise, cooling water is evaporated which results in serious damage to the engine.

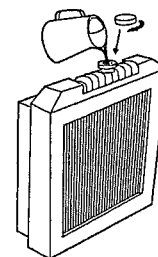
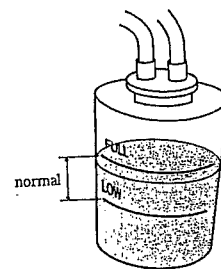

(3) Check on fan belt

(Read the instruction manual for the engine furnished separately.)

- ① Check the belt for tension and elongation. Also, check it for damage. Replace if necessary.
- ② For adjustment or replacement of the belt, refer to the instruction manual for the engine.

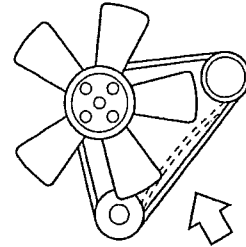

Press (about 6kg) the position shown by arrow mark (middle of belt) with your thumb.

The bend should be within the range of 10-12mm.

(4) Check on fuel

- ① Be sure to check the quantity of fuel prior to operation to prevent lack of fuel during operation.
- ② Loosen the drain plug of the fuel tank from time to time, and remove sediment's and water at the bottom of the tank.

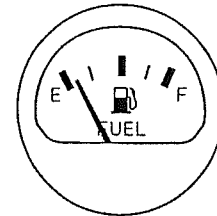

(5) Check on battery acid

⚠ CAUTION

Battery

■ The battery acid is dilute sulfuric acid. Improper handling will cause unexpected burns.

* When the battery acid gets on your clothes or skin, wash it out with a large volume of water immediately. If it gets in your eyes, wash with a large volume of water immediately and consult your doctor.

- In the worst case, it will put out your eyes.

Remove the battery acid plug(cap) and check the liquid level (10-12mm above the electrodes). Supply distilled water if necessary.

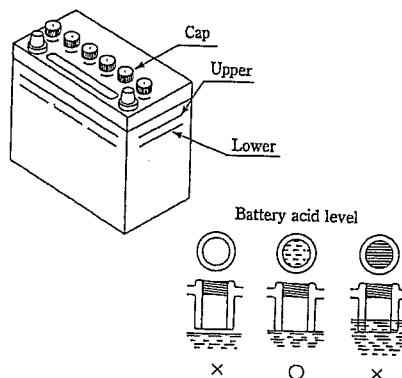

(6) Check grounding for electric shock protection

Make sure that the case grounding of the machine and the load are certain.

Do not ground directly 「O」 terminal.

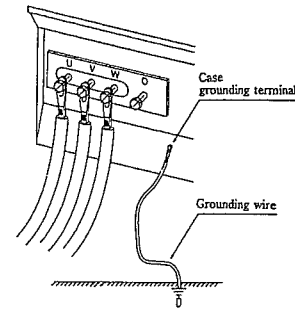

(7) Check for leak of water and oil

Check the machine for the trace of leak of oil or water. If a leak is found, check the location of leak and stop it.

When the leak cannot be stopped, contact our service factory.

(8) Check for loose parts

Check for loose bolts and nuts. Loose parts should be tightened firmly. Particularly, make check on (the fitting of air cleaner, muffler, turbo-charger, etc.), disconnection of electric wiring, short-circuit and loose terminals.

(9) Removal of foreign objects in machine

- * Check that tools and cleaning cloth are not left in the machine. Remove if necessary.
- * Check the surroundings of the muffler and engine for presence of dust and flammable objects. Remove if necessary.
- * Check that the cooling air inlet and the cooling air outlet of the machine are not clogged with dust or other objects. Remove if necessary.

5-2 Startup

Following is flow of startup.

circuit breaker : OFF

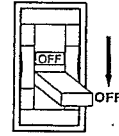

throttle handle : START / IDLING

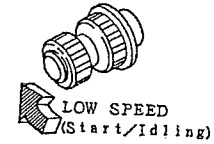

When engine is already warm.

starter switch : PREHEAT (keep more than 5 sec.)



preheat lamp : (check the preheat lamp goes off)

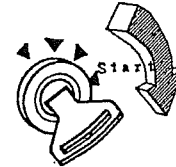

starter switch : START

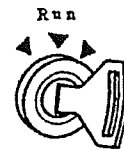

starter switch : RUN

engine startup

warm up operation : about 5 minutes
sufficiently (when it is cold.)

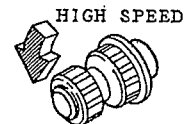

throttle handle : NO-LOAD position

adjustment of speed

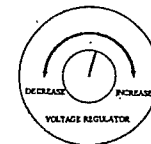

adjustment of voltage

circuit breaker : ON

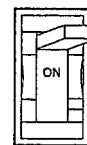

supply power to load

⚠ CAUTION

* Do not start the engine when the machine and the load circuit breaker are "ON" position, or else, power is supplied to the load at the start of the engine which causes electric shocks or trouble in the load.

Startup procedure

Turn the fuel cock of the water separator to open before starting engine.

(1) Make sure that the circuit breakers of the machine and the loads are all "OFF" position.

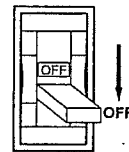

(2) Set the throttle handle in the "START/IDLING" position.

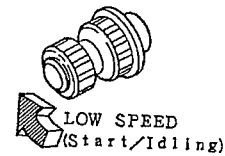

(3) Turn the starter switch to "PREHEAT" position, then preheat lamp goes on. This position is held until the preheat lamp goes off, then preheat is completion.



Turn the starter switch to "START" position until engine starts.

[Note] :

If the engine is warm, the preheat operation is not required.

(4) If engine starts up, set free the starter switch.

Make sure that 「Oil Pressure Failure」 in the warning lamp unit goes off.

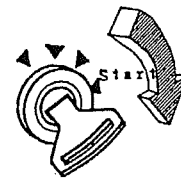

(5) Drive the machine for warming up the engine for about 5 minutes at the "START/IDLING" position of the throttle handle.

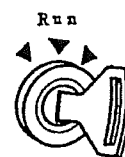

(6) After warming up the engine, set the throttle handle to the "RUN" position. And check on the idling speed is as specified in the following table by the frequency meter.

If the idling speed is not as specified or change of frequency is required, adjust the idling speed by the throttle handle.

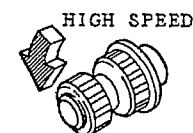

	Frequency (No Load Position)
Operation at 50Hz	52.5Hz (1575rpm)
Operation at 60Hz	62.5Hz (1875rpm)

If the idling speed set above speed, frequency becomes nearly 50Hz or 60Hz in the rated load.

(7) Set the voltage to the rated by the voltage regulator, and turn the breaker to "ON". The machine starts power transmission state.

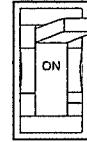
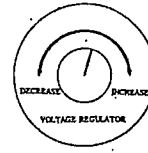

5-3 Handling during operation

(1) Checking after startup

① Make sure that each meter and lamp are normal.
normal : warning lamp is all off

② Make sure that the color of exhaust gases from the engine is normal. Check for unusual noise and vibration.

Color of exhaust gases

Colorless or light blue: Normal

Black: Abnormal, incomplete combustion

White: Abnormal, combustion of oil due to failure of oil

(2) Adjustment during operation

Set the frequency meter to the rated by the throttle handle.

Set the voltmeter to the rated by the voltage regulator.

[Note] :

Do not set the throttle handle in "START/IDLING" position during operation of the load, or else, the generator voltage and frequency will go down, resulting in failure in operation of the load device or any other trouble.

5-4 Shutdown

(1) Turn "OFF" the circuit breaker of the load.

circuit breaker of the load

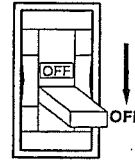

(2) Turn "OFF" the circuit breaker of the machine.

circuit breaker of the machine

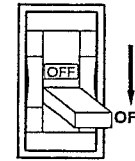

(3) Set the throttle handle in "START/IDLING" position and put the machine in cooling operation for about 5 minutes.

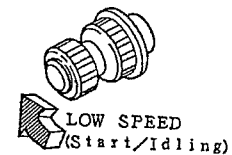

(4) Set the starter switch in "STOP" position. The engine will stop immediately.

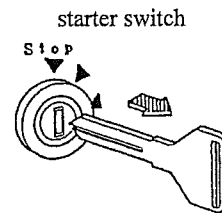

(5) Remove the key from the starter switch and keep it at hand.

(6) Check the amount of fuel. Supply additional fuel if necessary.

(7) Check for leakage of oil, fuel and water.

5-5 Protection device

Protection devices and emergency stop devices are provided for protection of the machine against trouble during operation.

When the warning lamp lights, stop the engine immediately. Check and remove the cause of trouble.

Table of protection device

warning \ action	turn OFF the circuit breaker	stop the engine	indicate by warning lamp	function
high jacket water temperature (WATER TEMP.)	—	○	○	When the cooling water temperature rises abnormally, the device acts. Set point: 115°C
oil pressure failure low lubricating oil (OIL PRESS.)	—	○	○	When the oil pressure falls abnormally, the device acts. Set point: 49kPa
fuel level failure (FUEL LEVEL)	—	—	○	When fuel supply is necessary because of fuel shortage, the device acts.
battery acid level failure (BATTERY LOW LEVEL)	—	—	○	When the battery acid is failure, the device acts.
air filter blinding (AIR FILTER)	—	—	○	When replace or cleaning of air filter is necessary because of blinding of filter, the device acts
Over-current of generator	○	—	—	When over-current flows, the device acts.
insufficient charge	—	○	○	When insufficient charge, the device acts.

6. Lubrication, cooling water and fuel

6-1 Engine oil

Use specified engine oil, otherwise, it greatly affects the startup operation and life of the engine.

(1) Kind of oil

Use oil, CD class or higher, classified by API service.

(2) Oil viscosity

Recommended oil viscosity is SAE 10W-30, all-season type.

Use oil according to ambient temperature referring to the table below.

Ambient temperature (°C)						
-30	-20	-10	0	10	20	30
		← SAE 20 →				
			← SAE 30 →			
← SAE 5W-20 →						
← SAE 10W-30 →						
← SAE 15W-40 →						

[Note] :

Do not mix with different kind of oil, or else, it deteriorates the oil quality.

(3) Total quantity of replacement oil

13.2 L (0.4 L)

(Value in parenthesis is filter capacity.)

6-2 Cooling water

(1) Water for cooling

Use the mixture of the good quality soft water like city water and the Long Life Coolant (LCC) of anti-freeze and anti-rust for the aluminum radiator

Percentage of LLC must be 30% to 50%. Under 30%, the anti-rust effect will decrease, and over the 50%, the anti-freeze effect will decrease.

The following percentages are recommended for each ambient temperature;

30%: -10°C

40%: -20°C

50%: -30°C

In case of replenishment, use LLC of the same brand and the same density.

Normally LLC should be replaced every 2 years.

(2) Total quantity of cooling water

9.5 L (1.0 L)

(Value in parenthesis is reserve tank capacity.)

6-3 Fuel

(1) Fuel to be used

#2 Diesel Fuel

[Note] :

If other kinds of fuel is used or fuel being used contains water or dust, it deteriorates the engine performance or leads to a serious trouble.

7. Handling of battery

⚠ CAUTION

Battery

■ Battery generates flammable gases. Improper handling may lead to explosion or serious injury.

- * Battery should be charged in a well ventilated location. Otherwise, flammable gases are accumulated which may be ignited and exploded.
- * When connecting a booster cable, do not jumper the terminals (+ and -). Otherwise, the flammable gases generated from the battery may be ignited and exploded by sparks.
- * For maintenance of the machine, disconnect the cable on the ground side.

■ The battery acid is dilute sulfuric acid. Improper handling will cause unexpected burns.

* When the battery acid gets on your clothes or skin, wash it out with a large volume of water immediately. If it gets in your eyes, wash with a large volume of water immediately and consult your doctor.

- In the worst case, it will put out your eyes.

■ For checking or handling of the battery, be sure to stop the engine in advance.

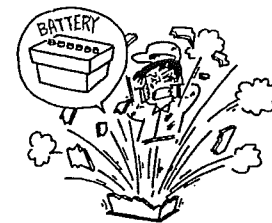
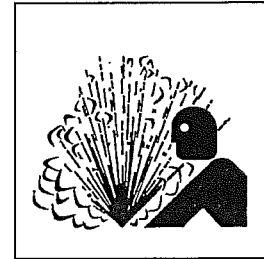

7-1 Caution on battery charge

Charging of loaded battery

- * Disconnect the wiring cable from the battery terminals before charging.
(Otherwise, the alternator may be damaged due to unusual voltage applied to the alternator)
- * When disconnecting the wiring cables from the battery terminals, remove the ground cable first.
(If a tool touches the space between the "+" terminal and the machine, electric spark will occur which is very dangerous)
When connecting the wiring cables to the battery terminals, connect the ground cable last.
- * While the battery is being charged, open all the liquid plugs to discharge the gas.
Keep the battery away from fire to prevent unexpected explosion.
Handle the battery carefully to prevent electric sparks.
- * If the battery is overheated (liquid temperature above 45°C), stop charging for a while.
- * At the completion of charging, stop charging immediately.
(The relation between battery charge condition and specific gravity See p.40)
If the battery is still charged, the following trouble will occur.
 - 1) Battery overheat
 - 2) Decrease in battery acid
 - 3) Deterioration of battery performance
- * Do not connect the battery polarity in reverse (connection of "+" and "-" or "-" and "+") to prevent damage to the alternator or the like.

7-2 Connection of booster cable, and installation

When the engine is started using booster cables, connect the cables as follows.

(1) Connection of booster cable

- ① Connect the clip of the booster cable "A" to the terminal "+" of the machine in trouble.
- ② Connect the other clip of the booster cable "A" to the terminal "+" of the normal machine.
- ③ Connect the clip of the booster cable "B" to the terminal "-" of the normal machine.
- ④ Connect the other clip of the booster cable "B" to the engine block of the machine in trouble.

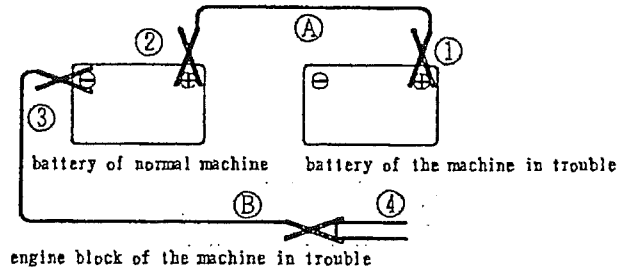

(2) Removal of booster cable

- ① Remove the clip of the booster cable "B" connected to the engine block of the machine in trouble.
- ② Remove the clip of the booster cable "B" connected to the terminal "-" of the normal machine.
- ③ Remove the clip of the booster cable "A" connected to the terminal "+" of the normal machine.
- ④ Remove the clip of the booster cable "A" connected to the terminal "+" of the machine in trouble.

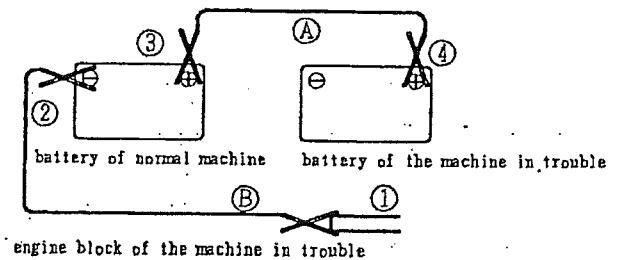

(3) Caution on handling of booster cable

- ① Use booster cables and clips of the size that matches the size of battery.
- ② The battery used for normal machine should be the same in capacity as the battery of the machine in trouble.
- ③ After connection, check that clips are firmly connected.
- ④ When connecting booster cables, make sure that the terminal "+" does not touch the terminal "-".
- ⑤ The engine block should be connected at a place more than 30cm away from the battery.

8. Periodical checking and maintenance

(Read the instruction manual for the engine furnished separately)

⚠ WARNING

MOVING PARTS can cause severe injury.

■ Rotary unit which moving parts at a high speed is located in the machine. Care should be taken during operation.

* When the machine needs checking or maintenance, be sure to stop it in advance.

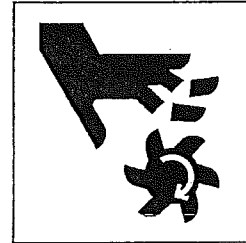

⚠ WARNING

ELECTRIC SHOCK can kill.

■ High voltage units are located in the machine. Care should be taken during operation.

* When the machine needs checking or maintenance, be sure to stop it in advance.



⚠ CAUTION

HOT PARTS can burn skin.

■ High temperature parts are located in the machine. Care should be taken during operation.

* When the machine needs checking or maintenance, be sure to stop it in advance.

* Even after the machine stops, the inside of the bonnet is still hot. Wait until the engine is cooled sufficiently.

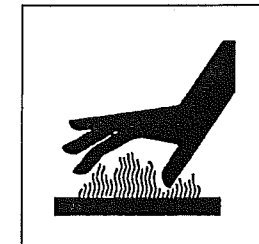

⚠ CAUTION

Battery

■ Battery generates flammable gases.

Improper handling may lead to explosion or serious injury.

* For maintenance of the machine, disconnect the cable on the ground side.

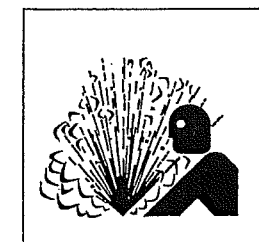

⚠ CAUTION

Sign for maintenance

- * During checking or maintenance, be sure to put up a sign "Under maintenance" at a conspicuous place such as the starter switch to prevent the machine from being operated by other persons.

⚠ CAUTION

Safety clothes

- * During checking or maintenance, be sure to put on suitable clothes and protectors.
- * Do not put on baggy clothes, necklace, etc., because they are easily caught by projections which may cause injuries.

⚠ CAUTION

Handling of waste liquid

- * Waste liquid from the machine should be received in a vessel.
- * Do not dispose of waste liquid recklessly, as it causes environment pollution.
Do not throw it on the ground or in rivers, lakes, sea, etc.
- * Lubrication, fuel, cooling water (coolant) and other harmful objects such as filter, battery etc., should be disposed of according to the related regulations.

8-1 Maintenance schedule

50 hours: Checking/first 50hours

- * Change of engine oil
- * Replacement of engine oil filter cartridge

100 hours: Checking/every 100 hours

- * Cleaning of air cleaner element
- * Cleaning of water separator

250 hours: Checking/every 250 hours

- * Change of engine oil
- * Measurement of generator insulation resistance
(once a month)
- * Check of battery specific gravity

500 hours: Checking/every 500 hours

- * Replacement of engine oil filter cartridge
- * Replacement of fuel filter cartridge
- * Cleaning of radiator
- * Checking for terminal and connection of the circuit
- * Replacement of fan belt

1000 hours: Checking/every 1000 hours

- * Cleaning inside of fuel tank
- * Replacement of air cleaner element
- * Check on rubber suspension
- * Check on nylon and rubber hose
- * Check on lining

On the engine system, main checking items only are shown in this manual.
For details, refer to the instruction manual for the engine furnished separately.

8-2 Checking/first 50 hours

(1) Change of engine oil

Change the engine oil at 50 hours only first time and every 250 hours after second time.

- ① Remove the engine oil drain plug and discharge oil completely. It can be discharged easily when the engine is warm.
- ② After engine oil is discharged, tighten the plug firmly.
- ③ Charge new engine oil from the oil filler until it reaches the notched line of the "H" on the dipstick.
- ④ After engine oil is supplied, run the engine for a few minutes. Check that oil is supplied to the level between H and L.

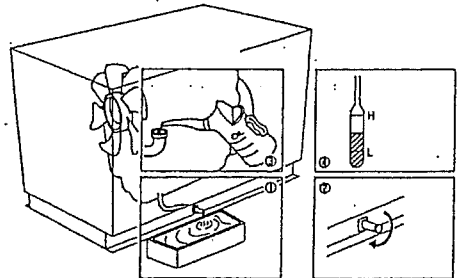

(2) Replacement of engine oil filter cartridge

Replace the engine oil filter cartridge at 50 hours only first time and every 500 hours after second time.

Remove the drain plug and discharge oil completely in advance.

- ① Remove the cartridge using filter wrench.
- ② Clean the filter base. Coat the packing of new cartridge with engine oil thin. Then, mount the cartridge.
 - When mounting, tighten the cartridge from 3/4 to 1 turn by using filter wrench after the packing is fitted to the seal of the filter base.
- ③ After the cartridge is replaced, run the engine for a while. Then, check to see that oil is supplied to the level between H and L

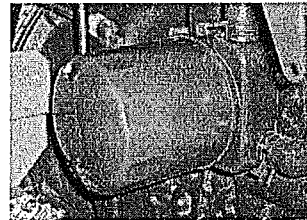

● Parts number of oil filter cartridge

parts number

06020 41272 KUBOTA 10020-32430

8-3 Checking/every 100 hours

(1) Cleaning of air cleaner element

— Dry dust clings on element —

Remove the air cleaner element and clean the element with dry and clean compressed air.

* While it is being cleaned, check the element for any damage. Replace if necessary.

* Before installing the air cleaner, wipe off dirt on the element cover.

* When insert the element, insert the element completely pressing equal edge of element.

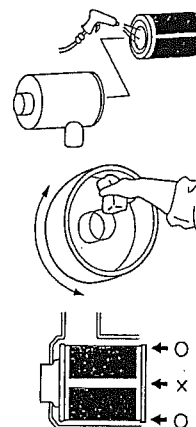

(2) Cleaning of water separator

① Close the cock of the water separator, loosen the screw ring, and remove the element with the see-thru bowl.

② Rinse the element and the bowl with diesel fuel.

③ After cleaning, reinstall the water separator, keeping out of dust and dirt.

④ Discharge air in the fuel piping

-For details, refer to the instruction manual for the engine.

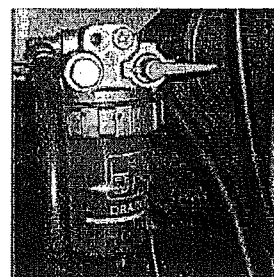

8-4 Checking/every 250 hours

(1) Change of engine oil

Refer to 「8-2.(1) Change of engine oil See p.38」 .

(2) Measurement of insulation resistance.

⚠ WARNING

ELECTRIC SHOCK can kill.

* Measurement should be made after the machine stops.



* Using a 500V megger, make a check once a month to ensure that the insulation resistance is more than 1MΩ.

Measurement:

Disconnect the load side cable from the output terminal. Turn ON the circuit breaker and measure the insulation resistance between the output terminal bolt and the bonnet.

* If the measured resistance is less than 1MΩ, it may cause electric leakage or fire accident.

Wipe off dirt and oil on the output terminals, circuit breakers and generator leads (cables) and dry them thoroughly.

If the insulation resistance is not recovered after cleaning, contact distributor or our office.

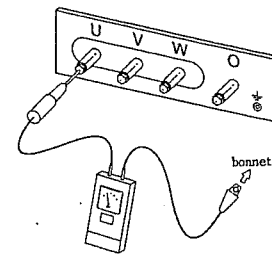

(3) Check on battery specific gravity.

If battery is likely to be discharged due to failure in startup of the engine, measure the specific gravity of battery acid.

The relation between battery charge condition (charging rate) and specific gravity is as shown below.

Liquid temp. °C Charging rate (%)	20	0	-10
	100	1.28	1.29
90	1.26	1.27	1.28
80	1.24	1.25	1.26
75	1.23	1.24	1.25

Each value has a deviation of ±0.01.

When the charging rate is below 75%, the battery needs to be recharged.

「7-1. Caution on battery charge See p.33」

8-5 Checking/every 500 hours

Checking/every 100 and 250 hours is also required.

(1) Replacement of engine oil filter cartridge

Refer to 「8-2.(2) Replacement of engine oil filter cartridge
See p. 38」 .

(2) Replacement of fuel filter cartridge.

- ① Remove the cartridge using filter wrench.
- ② Clean the filter base. Coat the packing of new cartridge with engine oil thin. Then, mount the cartridge.
-When mounting, tighten the cartridge about from 1/2 to 3/4 turns by hand after the packing is fitted to the seal of the filter base.
- ③ After the cartridge is replaced, discharge air in the fuel piping
-For details, refer to the instruction manual for the engine.

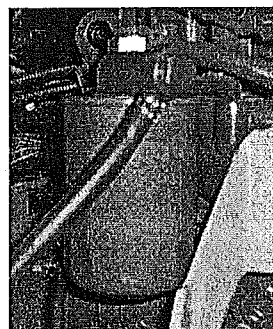

● Parts number of fuel filter cartridge

parts number

06020 42552 KUBOTA 16631-43560

(3) Cleaning of radiator

When the fin or tube is blinded, it should be cleaned with steam or running water.

Do not use a high pressure washer to prevent damage to the fin and tube.

(4) Checking for terminal and connection of the circuit.

Check for main and sub circuit whether there are no abnormality such as loosening, corrosion and burning, etc.

(5) Replacement of fan belt

Refer to the instruction manual for the engine furnished separately.

● Parts number of fan belt

parts number

06020 11440 KUBOTA 1G517-97011

8-6 Checking/every 1000 hours

Checking/every 100, 250 and 500 hours is also required.

(1) Cleaning inside of fuel tank

Drain the fuel in the fuel tank completely, and wash out deposits and water collected inside the tank.

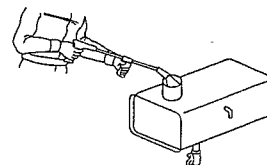

(2) Replacement of air cleaner element

The element should be replaced referring to "Cleaning of air cleaner element" (See p.39) .

● Parts number of air cleaner element

parts number

06020 46336

WAKO 11307-3000

(3) Check on rubber suspension

Check on the rubber suspension whether it is damaged or deformed by the oil.

Contact distributor or our office to replace the rubber suspension, if necessary.

(4) Check on nylon and rubber hose

Check on the nylon and rubber hose whether they are hardened or deteriorate.

Contact distributor or our office to replace the nylon hose and rubber hose, if necessary.

(5) Check on lining

Check on the lining whether it deteriorates greatly, or it is stained by clinging of oil or the like, or it is removed. Contact distributor or our office to replace the lining, if necessary.

8-7 Table of periodical maintenance and checking

◇:Check or Clean ○:Replacement ☆:Only first time

	List of maintenance and inspection	daily	first 50h	every 100h	every 250h	every 500h	every 1000h
Engine	Checking on oil level and stain of oil	◇					
	Checking on cooling water	◇					
	Checking on fan belt	◇					
	Checking on fuel and drain	◇					
	Checking on battery acid level	◇					
	Checking on for water and oil leakage	◇					
	Checking on bolts and nuts for looseness	◇					
	Checking on exhaust color, sound and vibration	◇					
	Checking on meters and warning lamps	◇					
	Change of engine oil		☆○		○		
	Replacement of engine oil filter		☆○		○		
	Cleaning air cleaner element			◇			
	Cleaning water separator			◇			
	Checking on specific gravity of battery				◇		
	Cleaning radiator					◇	
	Replacement of fuel filter					○	
	Cleaning fuel tank						◇
	Replacement of air cleaner element						○
	Checking on rubber suspension						◇
	Checking on nylon and rubber hose						◇
Checking on lining						◇	
	Inspection of engine valve clearance				※		
	Adjust fuel injection nozzle				※		
	Inspection of timing of fuel injection				※		
Generator	Checking on generator case grounding	◇					
	Checking on insulation resistance				◇		
	Checking on terminal and connected section					◇	

※ Contact distributor or our office.

In detail, please refer to "Engine Instruction Manual" furnished separately.

9. Troubleshooting

⚠ WARNING

MOVING PARTS can cause severe injury.

■ Rotary unit which moving parts at a high speed is located in the machine.

Care should be taken during operation.

* When the machine needs checking or maintenance, be sure to stop it in advance.

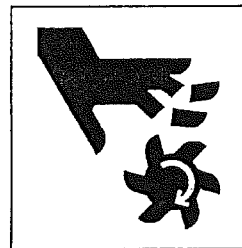

⚠ WARNING

ELECTRIC SHOCK can kill.

■ High voltage units are located in the machine. Care should be taken during operation.

* When the machine needs checking or maintenance, be sure to stop it in advance.

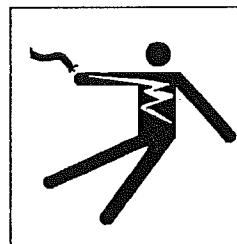

⚠ CAUTION

HOT PARTS can burn skin.

■ High temperature parts are located in the machine. Care should be taken during operation.

* When the machine needs checking or maintenance, be sure to stop it in advance.

* Even after the machine stops, the inside of the bonnet is still hot. Wait until the engine is cooled sufficiently.

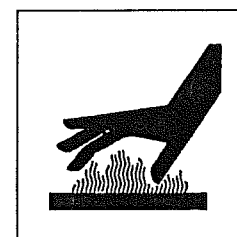

⚠ CAUTION

Battery

■ Battery generates flammable gases.

Improper handling may lead to explosion or serious injury.

* For maintenance of the machine, disconnect the cable on the ground side.

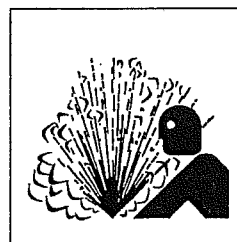

Phenomenon		Assumed cause	Action
Engine will not start up	Cell motor will not run or revolving speed is low	Discharged battery	Charge or replace
		Detached or loosened or Corroded battery terminal	Repair
		Fuse blow	Replace
		Improper starter switch	Replace
		Improper starter	Replace
		Broken lead wire	Repair
	Cell motor runs	Fuel shortage	Supply
		Blinded fuel filter	Replace filter
		Air in fuel system	Remove
	Speed will not rise	Air in fuel system	Remove
Blinded fuel filter		Replace filter	
Compression failure		Repair engine	
Blinded air cleaner		Replace element	
Engine stop by oil failure	Oil shortage	Supply	
	Oil pressure switch failure	Replace	
	Blinded oil filter	Replace filter	
Over heat (water temperature)	Cooling water shortage	Supply	
	Fan belt looseness	Adjust	
	Blinded core of radiator	Cleaning	
	Engine thermostat failure	Repair	
Voltmeter will not operate	Voltmeter failure	Replace	
	AVR failure	Contact distributor or our office	
	Burned ZNR		
	Quenched residual magnetism		
	Burned rotary rectifier		
	Disconnected rotor wiring		
Burned generator wiring			
Rated voltage will not be reached	Voltmeter failure	Replace	
	AVR failure	Contact distributor or our office	
	VR failure		
	Burned rotary rectifier		
	Burned ZNR		
	Burned generator wiring		
Low speed	Increase		
Voltage goes too high	Voltmeter failure	Replace	
	AVR failure	Contact distributor or our office	
	VR failure		
Applied load causes load voltage drop	Burned rotary rectifier	Contact distributor or our office	
	AVR failure		
	Burned main field, exciter field wiring		
	Unbalanced load	Balance	

10. Long-term storage

When the machine is to be stored for a long period of time, choose a cool place free from moisture and dust, and observe the following points.

- (1) Remove dirt clung the machine and clean it thoroughly.
If painting is peeled off, it should be repaired.
- (2) Remove the battery from the machine.
The battery should be charged completely before it is stored.
-Battery is discharged of itself. Recharge it once a month.
- (3) If any defects are found, check and repair the machine so that it can be used for future operation.
- (4) For details of handling the engine, refer to the instruction manual for the engine provided separately.

⚠ CAUTION

Stacking

■ Improper stacking of machines may cause falling or dropping accidents.

When stacking other machines on this machine, be sure to observe the following points.

- * Check that the bonnet of the machine is free from damage and that the fixing bolts are not loosened and missing.
- * Put the machine horizontally on a solid foundation which withstands the weight of stacked machines.
- * Machines can be stacked up to 2 stages. The weight and size of stacked machines should be less than those of this machine.
- * Using square timbers as shown right, put each machine making sure that the weight is even.

■ Do not operate the machines in the state of stacking to prevent falling or dropping accidents.

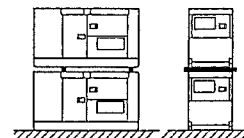

11. Service data

11-1 Specifications

	MODEL	DCA-35SPK	
A C G E N E R A T O R E N G I N E S E T	MODEL	DB-0391KU	
	FREQUENCY	50Hz	60Hz
	RATED OUTPUT	30kVA	35kVA
		24kW	28kW
	RATED VOLTAGE	400V	440V
	RATED CURRENT	43.3A	45.9A
	POWER FACTOR	0.8 (lagging)	
	NO.OF PHASES	Three-phase(four wire)	
	EXCITATION	Brushless type (with automatic voltage regulator)	
	NO.OF POLES	4	
	SPEED	1500min ⁻¹	1800min ⁻¹
	INSULATION	class F	
	MANUFACTURE	KUBOTA	
	MODEL	V3300-EB	
	TYPE	Vertical, water-cooled, 4-cycle diesel engine	
NO.OF CYLINDERS BORE×STROKE(mm)	4 - 98 × 110		
TOTAL DISPLACEMENT	3.318 L		
RATED OUTPUT (1500/1800min ⁻¹)	28.3kW	32.4kW	
BATTERY (DOMESTIC STANDARD)	95D31R × 1		
FUEL	DIESEL FUEL ASTM No.2 or equivalent		
FUEL TANK CAP.	82 L		
ENGINE OIL*1	OVERALL	13.2 L	
	FILTER	0.4 L	
COOLANT QUANTITY*2	OVERALL	9.5 L	
	RESERVE TANK	1.0 L	
LENGTH OVERALL	1900 mm		
WIDTH OVERALL	860 mm		
HEIGHT	990 mm		
DRY WEIGHT	890 kg		
TOTAL WEIGHT	1000 kg		

The above specifications and set dimensions are subject to change.

*1 Overall of engine oil contains filter.

*2 Overall of coolant quantity contains reserve tank.

Dry weight : This weight does not contain the cooling water, engine oil and fuel.

Total weight : This weight contains the cooling water, engine oil and fuel.

11-2 AC generator specifications (for custom voltage)

		50Hz						
Rated output	kVA	30	30	27	30	30	30	27
	kW	24	24	21.6	24	24	24	21.6
Rated voltage (V)		190	200	220	380	400	415	440
Rated current (A)		91.2	86.6	70.9	45.6	43.3	41.7	35.4

		60Hz							
Rated output	kVA	31.5	35	35	35	31.5	35	35	35
	kW	25.2	28	28	28	25.2	28	28	28
Rated voltage (V)		190	200	220	240	380	400	440	480
Rated current (A)		95.7	101	91.9	84.2	47.9	50.5	45.9	42.1

11-3 Outline drawing

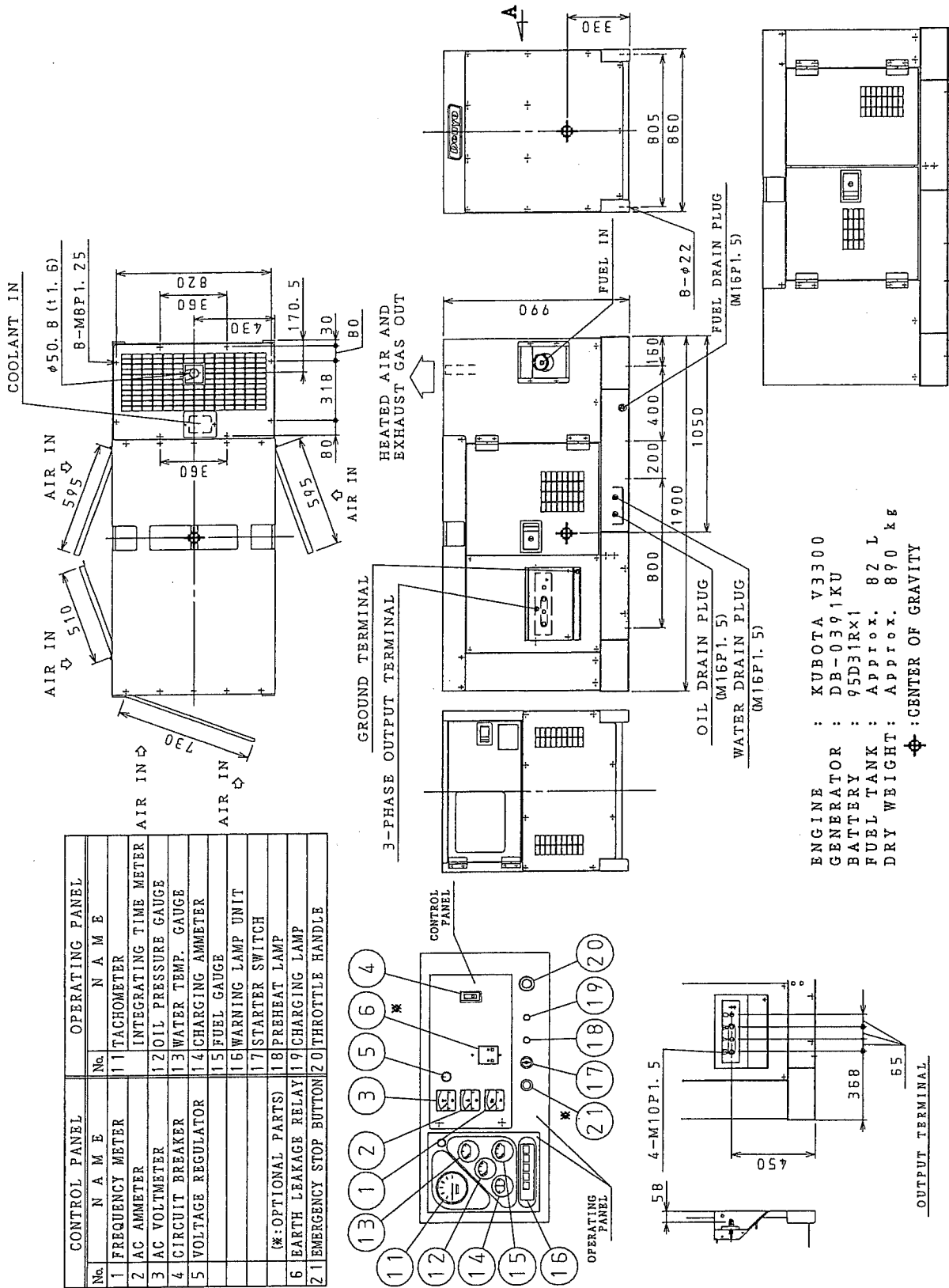

CONTROL PANEL		OPERATING PANEL	
No.	N A M E	No.	N A M E
1	FREQUENCY METER	11	TACHOMETER
2	AC AMMETER	12	INTEGRATING TIME METER
3	AC VOLTMETER	13	OIL PRESSURE GAUGE
4	CIRCUIT BREAKER	14	WATER TEMP. GAUGE
5	VOLTAGE REGULATOR	15	CHARGING AMMETER
		16	FUEL GAUGE
		17	WARNING LAMP UNIT
		18	STARTER SWITCH
		19	PREHEAT LAMP
6	EARTH LEAKAGE RELAY	20	CHARGING LAMP
21	EMERGENCY STOP BUTTON		THROTTLE HANDLE

ENGINE : KUBOTA V3300
 GENERATOR : DB-0391KU
 BATTERY : 95D31R×1
 FUEL TANK : Approx. 82 L
 DRY WEIGHT : Approx. 890 kg
 ⊕ : CENTER OF GRAVITY

'A' VIEW

11-4 Generator connection diagram

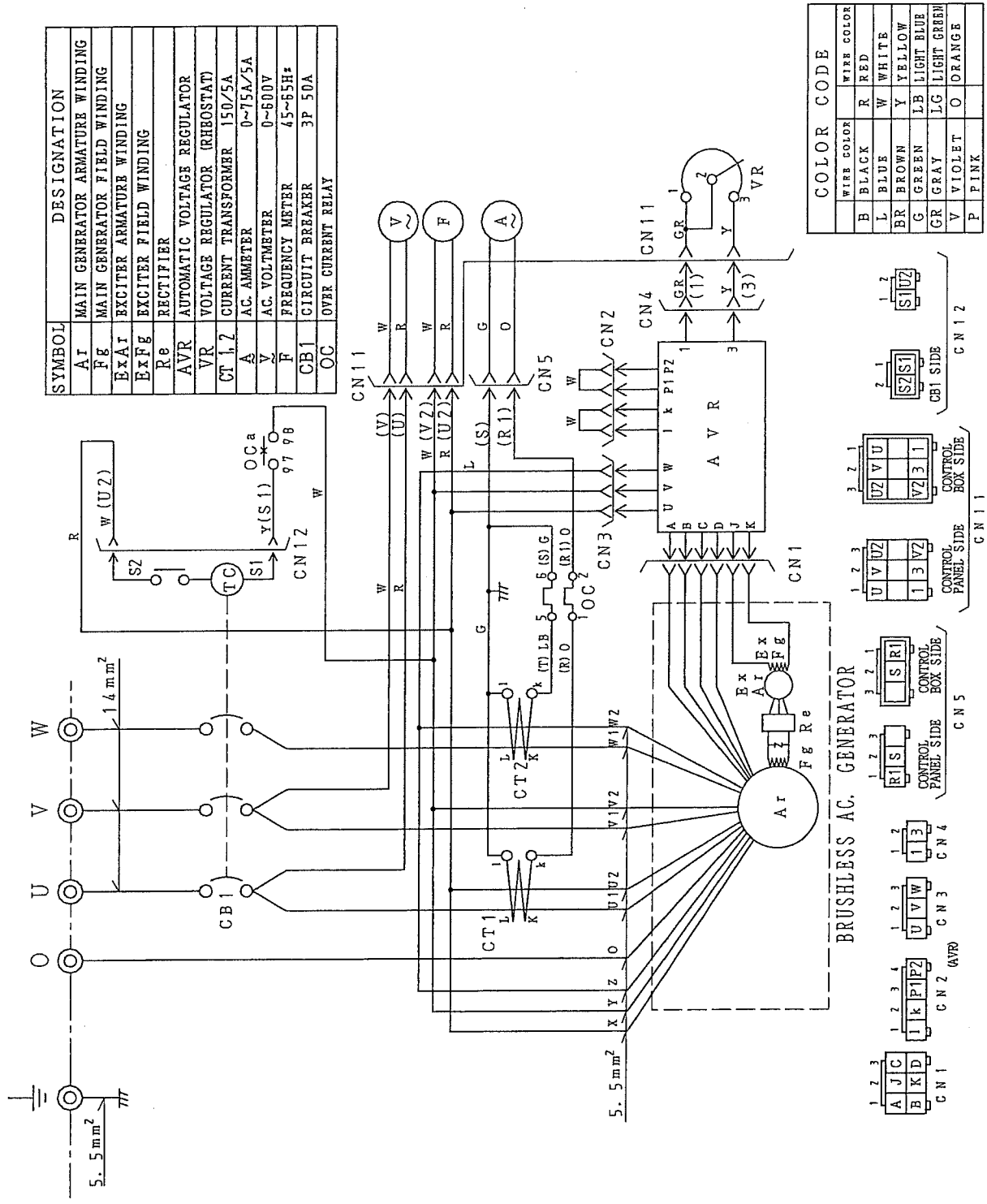

Notice :
1. No designation lead size : 1.25mm²

CONNECTOR ARRANGEMENT
(WIRING VIEW)

11-5 Engine wiring diagram

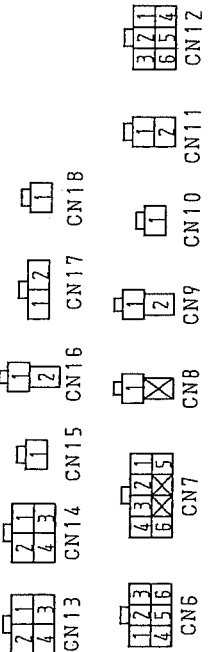
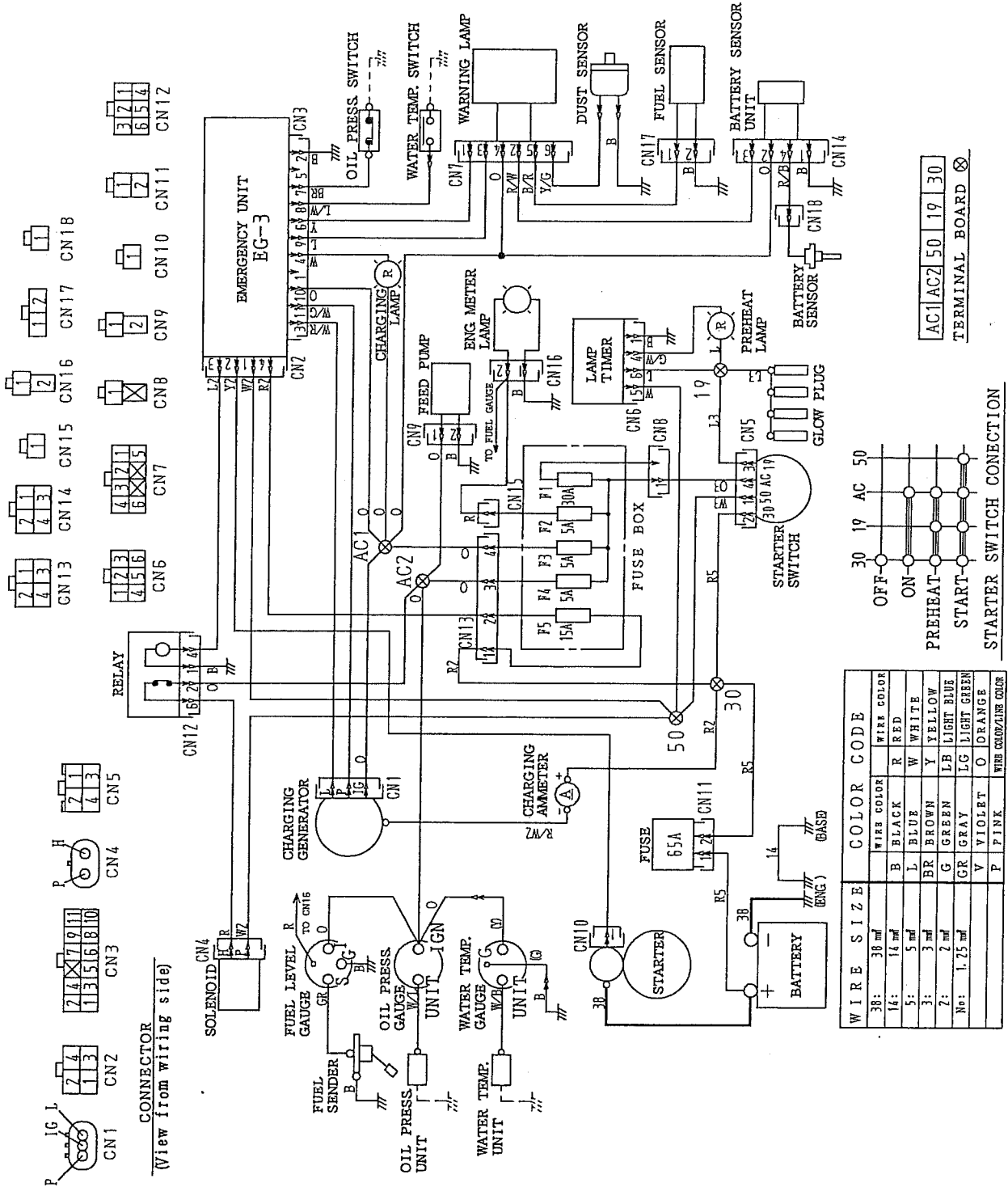

WIRE SIZE	COLOR CODE	WIRE COLOR	WIRE COLOR
38:	38	BLACK	R RED
14:	14	BLUE	W WHITE
5:	5	BROWN	Y YELLOW
3:	3	GREEN	LB LIGHT BLUE
2:	2	GRAY	LG LIGHT GREEN
No:	1.75	VIOLET	O ORANGE
		P PINK	WB WIRE COLOR/WIRE COLOR

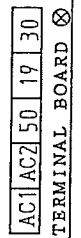
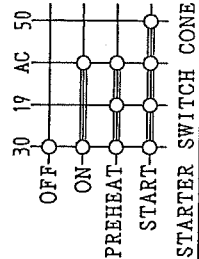

12. Options instruction manual

If equipment for the option device to the machine after the purchase is required, contact distributor or our office.

If the machine is modified on your own, the warranty of manufacturer will become invalid.

12-1 Earth leakage relay

⚠ WARNING

ELECTRIC SHOCK by leak can kill.

■ Improper grounding may lead to death due to electric shock. Because the device for leakage protection does not operate effectively.

* Grounding terminal for the earth leakage relay, case grounding terminal and case of the load are grounded.

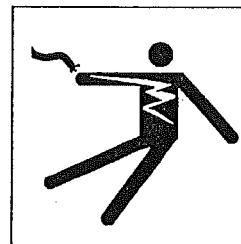

(1) Description of the device

The machine is provided with an earth leakage relay to detect any leakage produced due to such trouble as insulation failure of the load during operation and to cut off the circuit for protection against any accident such as electrocution resulting from the trouble.

The current sensitivity of this relay is 30 mA.

Improper handling of the relay may lead to unsafe condition in comparison with that does not use the relay.

To ensure further safety, install a leakage relay for each load at the position near the load.

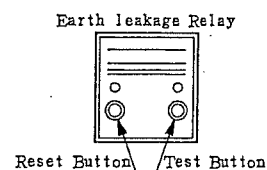

(2) Grounding

Ground as following to operate the earth leakage relay certainly.

■ Grounding of the machine

Ground the grounding terminal for earth leakage relay and case grounding terminal according to the below.

① Grounding of the grounding terminal for earth leakage relay

If grounding described below does not comply with the local rule, stricter of the two shall apply.

Use the grounding wire which sectional area is 5.5mm^2 or larger. Usually it is possible that using attached grounding rod. But if grounding resistance is over 100Ω , provide the grounding rod which surface area contacted the ground is large.

② Grounding of the case grounding of the machine

Refer to 「4-3(1) Case grounding of the machine See p.21」 .

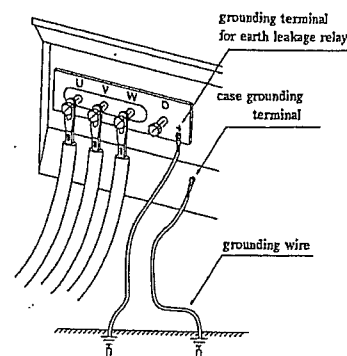

■ Grounding of the load equipment

As in the case of the machine, execute grounding work on the load equipment case. Provide the grounding rod to satisfy the grounding resistance which conforms to the local rule.

[Note] :

The installation of a leakage relay on the machine can not become a reason for elimination of the need for the load side grounding.

The load side grounding is indispensable for earliest possible detection of any leakage caused in the generator. The absence of such grounding requires any leakage to be detected by current flowing through the human body and is very dangerous because the sensitivity of leakage relay provided on the machine is not sufficient for detection of such current.

■ Precaution in grounding

Refer to 「4-3 (3) Precaution in grounding See p.21」

■ Operation check

For safety reasons, check on the operation of the leakage relay at the startup of the machine according to the procedure described below:

- ① Startup the machine according to 「5-2 Startup See p.26」 .
 - ② Make sure that all breakers of the load side are "OFF".
 - ③ Set the circuit breaker to "ON".
 - ④ Press the TEST button on the leakage relay. If this causes the LEAK lamp (red) on the leakage relay to go on and the breaker to be activated, the leakage relay can be regarded as operating normally.
 - ⑤ Press the RESET button and return the breaker to the "OFF" position. This allows the breaker to be turned to "ON" again.
- * The leakage relay, once it is activated, holds its activated state until the RESET button is pressed or the machine is stopped.

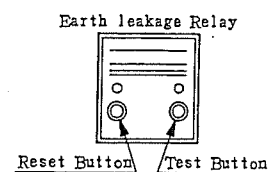

(3) Action for operation of the leakage relay

When the leakage relay is activated, then stop the engine and measure the insulation resistance several parts and repair the leak spot before restart the engine.