

MODELS | SJ 7127 SJ 7135 SJ 8831 SJ 8841 SJ 9250



Operating Manual

Mid-Size & Full-Size Rough Terrain Series (AS)

157938AA-A April 2011



This manual is based on Serial Number(s):

SJRT 71XX	34,001,951 & Above
SJRT 8831	36,000,233 & Above
SJRT 8841	40,000,728 & Above
SJRT 9250	50,000,746 & Above

Please refer to the website (www.skyjack.com) for older Serial Numbers.

Skyjack Service Center 3451 Swenson Ave. St. Charles, Illinois, 60174 USA

Phone: 630-262-0005

Toll Free: 1-800-275-9522

Fax: 630-262-0006

Email: service@skyjack.com

Parts (North America)

Toll Free: 1-800-965-4626

Toll Free Fax: 1-888-782-4825

Email: parts@skyjack.com

Parts & Service (Europe) Unit 1 Maes Y Clawdd, Maesbury Road Industrial Estate

Oswestry, Shropshire SY10 8NN UK

Phone: +44-1691-676-235

Fax: +44-1691-676-238

Email: info@skyjackeurope.co.uk

Skyjack Asia Pacific

Singapore

Phone: +65-6449-3710

Fax: +65-6449-7690

Email: skyjack@singnet.com.sg

The Safety Alert Symbol identifies important safety messages on aerial platform, safety signs in manuals or elsewhere. When you see this symbol, be alert to the possibility of personal injury or death. Follow the instructions in the safety message.



This Safety Alert Symbol means attention!

Become alert! Your safety is involved.



DANGER

DANGER indicates an imminently hazardous situation which, if not avoided, will result in death or serious injury.



WARNING

WARNING indicates a potentially hazardous situation which, if not avoided, could result in death or serious injury.



CAUTION

CAUTION indicates a potentially hazardous situation which, if not avoided, may result in minor or moderate injury. It may also be used to alert against unsafe practices.

IMPORTANT

IMPORTANT indicates a procedure essential for safe operation and which, if not followed, may result in a malfunction or damage to the aerial platform.

Table of Contents

Section 1 - About Your Aerial Platform	5
Reed and Heed	5
Safety Rules.....	6
Section 2 - Familiarization	11
2.1 Familiarization of SJRT Mid Size and Full Size Series.....	11
2.2 Component Identification.....	12
2.3 Visual & Daily Maintenance Inspections.....	16
2.4 Function Tests	26
2.5 Winching and Towing Procedure.....	36
2.6 Emergency Lowering Procedures	37
Section 3 - Operation	39
3.1 General	39
3.2 Major Components.....	40
3.3 Major Assemblies	41
3.4 Serial Number Nameplate.....	41
3.5 Component Identification.....	42
3.6 Component Identification (Special Options).....	44
3.7 Operator's Responsibility.....	46
3.8 Start Operation	47
3.9 Refueling Procedure.....	54
3.10 Loading/Unloading.....	55
3.11 Guardrail Folding Procedure.....	58
3.12 Maintenance Support Procedure.....	60
Section 4 - Tables.....	61
Table 4.1 Standard and Optional Features.....	61
Table 4.2 Owner's Annual Inspection Record	62
Table 4.3 Specifications and Features.....	63
Table 4.4 Maximum Platform Capacities (Evenly Distributed)	64
Table 4.5 Floor Loading Pressure.....	65
Table 4.6 Tire Specifications	67
Table 4.7 Maintenance and Inspection Schedule	68
Table 4.8 Operator's Checklist.....	69
Section 5 - Labels.....	71

SKYJACK is continuously improving and expanding product features on its equipment, therefore, specifications and dimensions are subject to change without notice.

Aerial Platform and Mobile Elevating Work Platform Definition

A mobile device that has a positionable platform supported from ground level by a structure.

Purpose of Equipment

The SKYJACK Rough Terrain's mid and full size aerial platforms are designed to transport and raise personnel, tools and materials to overhead work areas.

Use of Equipment

The aerial platform is a highly maneuverable, mobile work station. Work platform elevation and elevated driving must only be done on a firm level surface. It can be driven over uneven terrain only when the platform is fully lowered.

Manual

The operating manual is considered a fundamental part of the aerial platform. It is a very important way to communicate necessary safety information to users and operators. A complete and legible copy of this manual must be kept in the provided weather-resistant storage compartment on the aerial platform at all times.

Operator

The operator must read and completely understand both this operating manual and the safety panel label located on the platform and all other warnings in this manual and on the aerial platform. Compare the labels on the aerial platform with the labels found within this manual. If any labels are damaged or missing, replace them immediately.

Service Policy and Warranty

SKYJACK warrants each new SJRT Series aerial platform to be free of defective parts and workmanship for the first 24 months. Any defective part will be replaced or repaired by your local SKYJACK dealer at no charge for parts or labor. Contact the SKYJACK Service Department for warranty statement extensions or exclusions.

Optional Accessories

The SKYJACK aerial platform is designed to accept a variety of optional accessories. These are listed under "Standard and Optional Features" in [Table 4.1](#). Operating instructions for these options (if equipped) are located in [Section 3](#) of this manual.

For non-standard components or systems, contact the SKYJACK Service Department at

☎ : 44-1691-676-235

📠 : 44-1691-676-239

Include the model and serial number for each applicable aerial platform.

Scope of this Manual

- a. This MEWP meets requirements of the Guideline published by the National Regulators' Committee on High Risk Plant dated 27 May 2010.
- b. Operators are required to conform to national, state or territorial/provincial and local health and safety regulations applicable to the operation of this aerial platform.



WARNING

Failure to comply with your required responsibilities in the use and operation of the aerial platform could result in death or serious injury!

Operator Safety Reminders

A study conducted by St. Paul Travelers showed that most accidents are caused by the failure of the operator to follow simple and fundamental safety rules and precautions.

You, as a careful operator, are the best insurance against an accident. Therefore, proper usage of this aerial platform is mandatory. The following pages of this manual should be read and understood completely before operating the aerial platform.

Common sense dictates the use of protective clothing when working on or near machinery. Use appropriate safety devices to protect your eyes, ears, hands, feet and body.

Any modifications from the original design are strictly forbidden without written permission from SKYJACK.

Electrocution Hazard

This aerial platform is not electrically insulated. Maintain a Minimum Safe Approach Distance (MSAD) from energized power lines and parts as listed below. The operator **must allow** for the platform to sway, rock or sag. **This aerial platform does not provide protection from contact with or proximity to an electrically charged conductor.**

**DO NOT USE THE AERIAL PLATFORM AS A GROUND FOR WELDING.
DO NOT OPERATE THE AERIAL PLATFORM DURING LIGHTNING OR STORMS.**

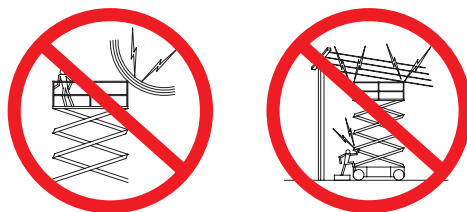

 <p>DANGER Avoid Power Lines</p>		
Minimum Safe Approach Distance		
AS 2550.10-2006 Requirements		
Voltage Range (Phase to Phase)	Minimum Safe Approach Distance (Meters)	
	Without Spotter	With Spotter
Up to and including 133KV	6.4	3
Greater than 133KV	10	8
FAILURE TO AVOID THIS HAZARD WILL RESULT IN DEATH OR SERIOUS INJURY!		

1013AA

Safety Precautions

Know and understand the safety precautions before going on to next section.



WARNING

Failure to heed the following safety precautions could result in tip over, falling, crushing, or other hazards leading to death or serious injury.

- **KNOW** all national, state/provincial and local rules which apply to your aerial platform and jobsite.
- **TURN** main power disconnect switch “○” off when leaving the aerial platform unattended. Remove the key to prevent unauthorized use of the aerial platform.
- **WEAR** all the protective clothing and personal safety devices issued to you or called for by job conditions.

- **DO NOT** wear loose clothing, dangling neckties, scarves, rings, wristwatches or other jewelry while operating this aerial platform.

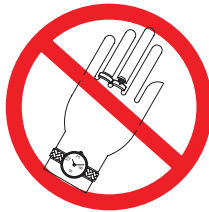

- **AVOID** entanglement with ropes, cords or hoses.



- **AVOID** falling. Stay within the boundaries of the guardrails.

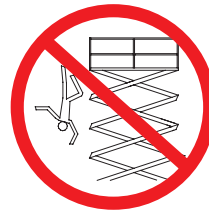

- **DO NOT** raise the aerial platform in windy or gusty conditions.



- **DO NOT** increase the lateral surface area of the platform. Increasing the area exposed to the wind will decrease aerial platform stability.



- **DO NOT** drive or elevate the aerial platform if it is not on a firm level surface. Do not drive elevated near depressions or holes of any type, loading docks, debris, drop-offs and surfaces that may affect the stability of the aerial platform.



- **If operation in areas with holes or drop-offs is absolutely necessary**, elevated driving shall not be allowed. Position the aerial platform horizontally only with the platform fully lowered. After ensuring that all 4 wheels or outriggers (if equipped) have contact with level firm surface, the aerial platform can be elevated. After elevation, the drive function must not be activated.



- **Elevated driving** must only be done on a firm level surface.

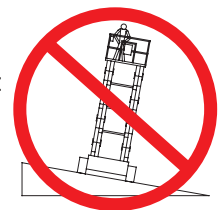

- **DO NOT** ascend or descend a grade when elevated. When fully lowered, ascending or descending, only grades up to rated maximum listed in [Table 4.3](#) are permissible.



Safety Precautions (Continued)

Know and understand the safety precautions before going on to next section.

- **DO NOT** operate on surfaces not capable of holding the weight of the aerial platform including the rated load, e.g., covers, drains, and trenches.

- **DO NOT** operate an aerial platform that has ladders, scaffolding or other devices mounted on it to increase its size or work height. It is prohibited.



- **DO NOT** exert side forces on aerial platform while elevated.



- **DO NOT** use the aerial platform as a crane. It is prohibited.



- **DO NOT** sit, stand or climb on the guardrails. It is prohibited.



- **DO NOT** climb on scissor arm assembly. It is prohibited.



- **BE AWARE** of overhead obstructions or other possible hazards around the aerial platform when driving or lifting.



- **DO NOT** raise the platform while the aerial platform is on a truck, forklift or other device or vehicle.



- **BE AWARE** of crushing hazards. Keep all body parts inside platform guardrail.

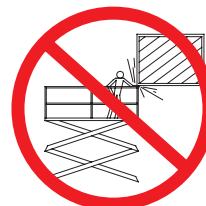

- **DO NOT** lower the platform unless the area below is clear of personnel and obstructions.



- **ENSURE** that there are no personnel or obstructions in the path of travel, including blind spots.

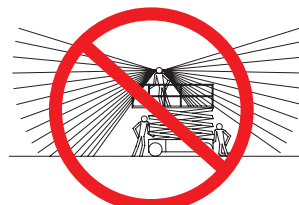

- **BE AWARE** of blind spots when operating the aerial platform.
- **STUNT** driving and horseplay are prohibited.
- **ENSURE ALL** tires are in good condition and lug nuts are properly tightened.
- **DO NOT** alter or disable limit switches or other safety devices.
- **DO NOT** use the aerial platform without guardrails, locking pins and the entry gate/chain/bar in place.

Safety Precautions (Continued)

Know and understand the safety precautions before going on to next section.

- **DO NOT** exceed the rated capacity of the aerial platform. Do make sure the load is evenly distributed on the platform.
- **DO NOT** attempt to free a snagged platform with lower controls until personnel are removed from the platform.
- **DO NOT** position the aerial platform against another object to steady the platform.
- **DO NOT** place materials on the guardrails or materials that exceed the confines of the guardrails unless approved by Skyjack.



WARNING

Entering and exiting the aerial platform should only be done using the three points of contact.

- Use only equipped access openings.
- Enter and exit only when the aerial platform is in the fully retracted position.
- Do use three points of contact to enter and exit the platform. Enter and exit the platform from the ground only. Face the aerial platform when entering or exiting the platform.
- Three points of contact means that two hands and one foot or one hand and two feet are in contact with the aerial platform or the ground at all times during entering and exiting.



WARNING

An operator should not use any aerial platform that:

- does not appear to be working properly.
- has been damaged or appears to have worn or missing parts.
- has alterations or modifications not approved by the manufacturer.
- has safety devices which have been altered or disabled.
- has been tagged or locked out for non-use or repair.

Failure to avoid these hazards could result in death or serious injury.

Jobsite Inspection

- Do not use in hazardous locations.
- Perform a thorough jobsite inspection prior to operating the aerial platform, to identify potential hazards in your work area.
- Be aware of moving equipment in the area. Take appropriate actions to avoid collision.

2.1 Familiarization of SJRT Mid Size and Full Size Series



WARNING

Aerial Platform Familiarization should be given only to individuals who are QUALIFIED And TRAINED to operate an aerial platform.

Do not operate this aerial platform without proper authorization and training. Failure to avoid this hazard could result in death or serious injury.

It is the responsibility of the operator to read, completely understand and follow all instructions and warnings contained in this operating manual and on the aerial platform.

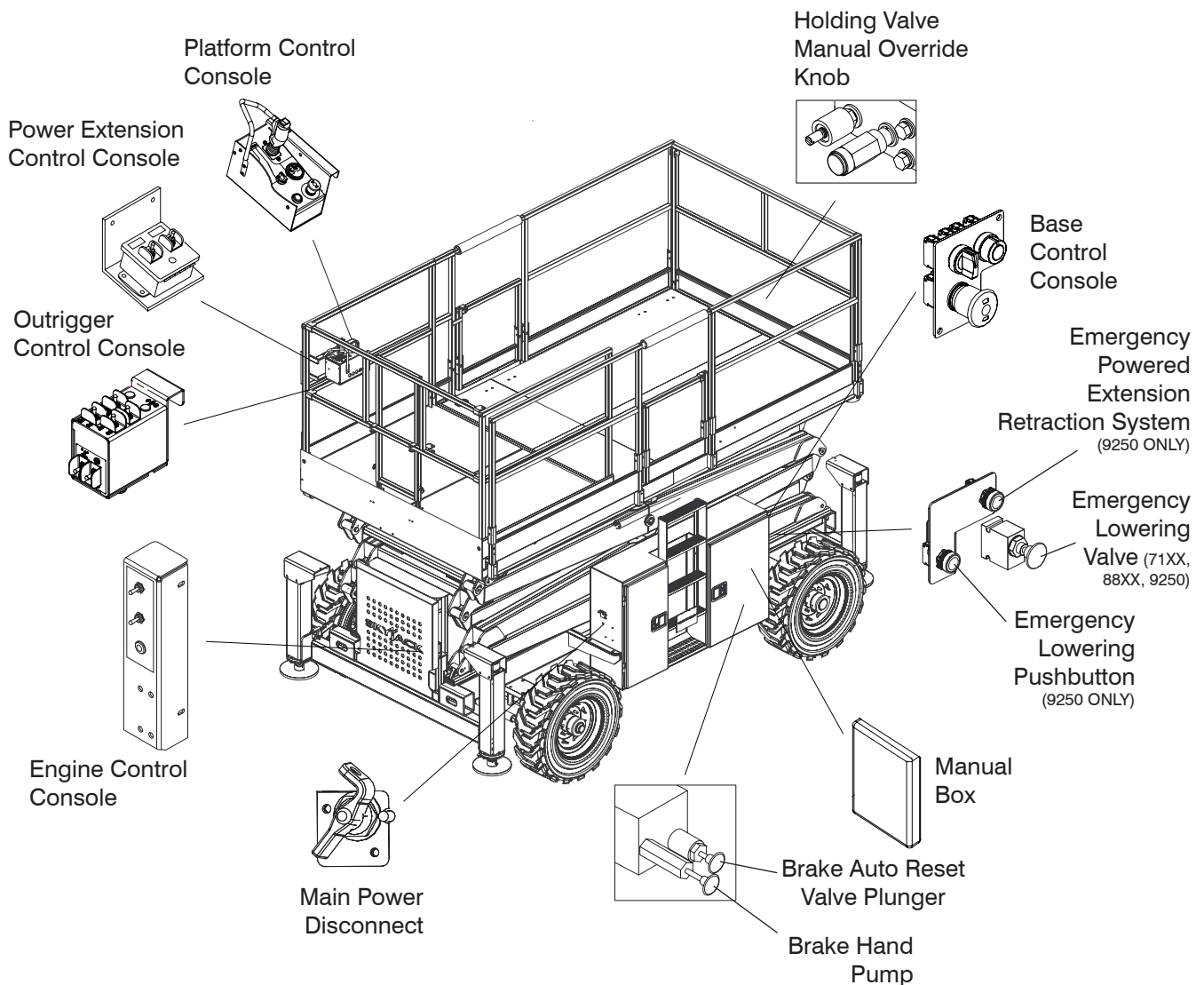

2.2 Component Identification

The following descriptions are for identification, explanation and locating purposes only.

2.2-1 Main Power Disconnect Switch

This switch is located at the side of the hydraulic/electrical compartment.

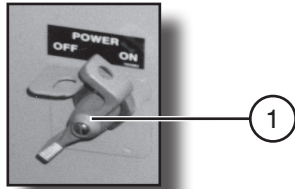

Figure 2-1. Main Power Disconnect Switch

1. **Main Power Disconnect Switch** - This switch, when in “○” off position, disconnects power to all circuits. Switch must be in “|” on position to operate any circuit. Turn switch off when transporting aerial platform.

2.2-2 Motion Alarm

The alarm produces an audible sound when any control function is selected. On aerial platforms with certain options, a flashing amber light will accompany this alarm.

2.2-3 Tilt Alarm

The aerial platform is equipped with a device which senses when the aerial platform is out of level in any direction. When activated, it disables drive and lift functions of the aerial platform and an alarm produces an audible sound accompanied by the amber light. If the alarm sounds, lower the platform completely, then reposition aerial platform so that it is level before raising the platform.

NOTE

If the tilt alarm sounds and the platform does not, or only partially raises, immediately lower the platform completely and ensure that the aerial platform is on a firm level surface.

2.2-4 Load Sensing System

This system is a safety device that prevents any normal movement of the aerial platform from a stationary working condition after the rated load is reached and exceeded. Refer to [Table 4.4](#) for maximum platform capacities.

- **When 90% of the rated load is reached:**
The red power indicator light on the platform control console flashes.
- **When the rated load is reached:**
An audible alarm sounds for approximately 2 seconds, 5 times per minute.
- **When the rated load is exceeded:**
The flashing light and audible alarm continue and all electrically controlled aerial platform movement functions stop. To resume normal operation, remove the overload from the platform.
- **If the aerial platform during the operation comes in contact with an overhead obstruction:**
The platform could become overloaded and all functions would stop. Release of the platform from this situation can only be effected by use of the emergency lowering system. Refer to [Section 2.6](#).

NOTE

After reaching full extension and upon lowering, the aerial platform could stop and take an overload reading. Return the proportional controller to the neutral center position, and release the enable trigger switch. If the aerial platform is overloaded, the flashing light and audible alarm continue and all electrically controlled aerial platform movement functions stop. To resume normal operation, remove the overload from the platform.

2.2-5 Base Control Console

This control console is located at the rear of the hydraulic/electrical compartment. It contains the following controls:

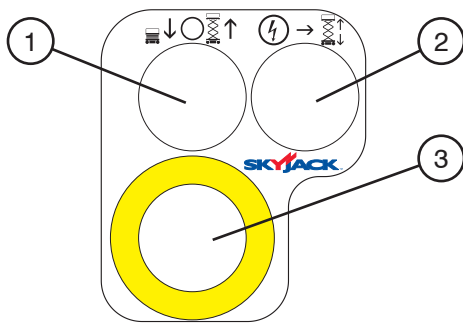
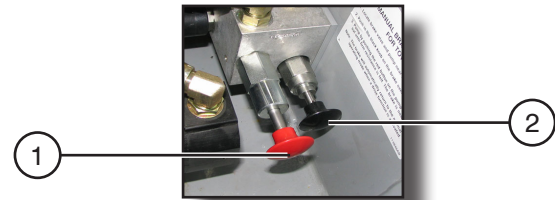

Figure 2-2. Base Control Console

1. **Lower/Neutral/Raise Switch** - This switch controls “” raising or “” lowering of platform.
2. **Enable Switch** - When selected and held, this “” switch allows the lift and auxiliary start functions to operate.
3. **Emergency Stop Button** - This button “”, when depressed, disconnects power to the control circuit.

2.2-6 Brake System

The brake system is located on the main manifold in the hydraulic/electrical compartment. The brake must be manually disengaged before pushing, winching or towing. Refer to [Section 2.5](#) for procedure on how to release the brake manually. The system contains the following controls:



Disc Brake

Figure 2-3. Brake System

1. Brake Hand Pump
2. Brake Auto Reset Valve Plunger

2.2-7 Emergency Powered Extension Platform Retraction System (Models 92xx)

This system is located in the hydraulic/electrical compartment. In the event of an emergency or an engine malfunction, this switch (item 1) can retract the powered extension platform from the base. Refer to [Section 3.8-9](#) for emergency retraction procedure.

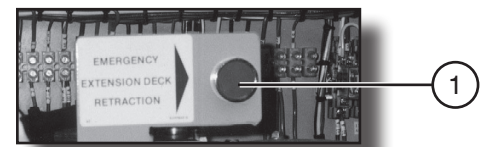

Figure 2-4. Emergency Powered Extension Platform Retraction System

2.2-8 Emergency Lowering System

This emergency lowering system allows platform lowering in the event of an emergency or an electrical system failure. Refer to [Section 2.6](#) for the emergency lowering procedures. The system contains the following controls:

Models 71xx & 88xx

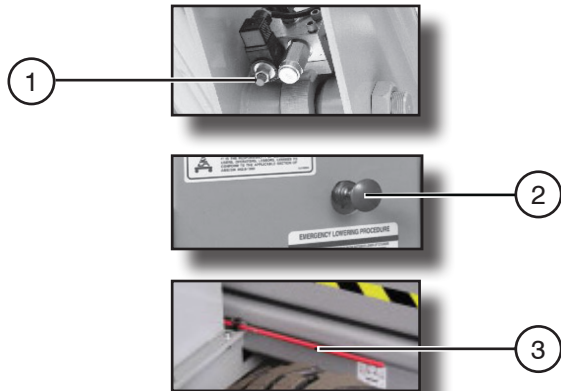

Figure 2-5. Emergency Lowering System

1. **Holding Valve Manual Override Knob** - Located on the holding valve at the bottom of each lift cylinder.
2. **Emergency Lowering Valve** - Located at the rear of the hydraulic/electrical compartment.
3. **Emergency Lowering Access Rod** - Located either at the base, on top of scissor guards, or on top of fuel cabinet.

Model 9250

This emergency lowering system is located on the hydraulic tank and is accessed through a hole in the hydraulic/electrical compartment door.

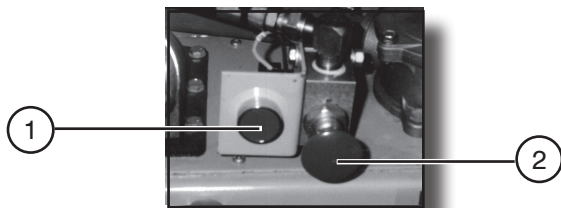

Figure 2-6. Emergency Lowering System

1. Emergency Lowering Pushbutton
2. Emergency Lowering Valve

2.2-9 Engine Control Console

This control console is attached to the engine tray. It contains the following controls:

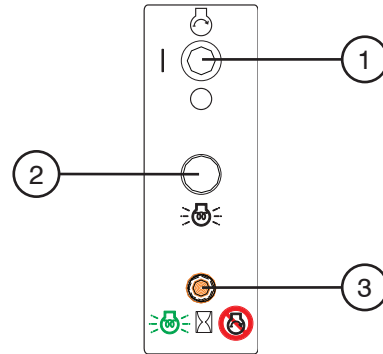

Figure 2-7. Engine Control Console - Diesel Engine

1. **Engine Off/On/Start Switch** - This is a three-position switch. When in “|” on position, it energizes engine circuit. When in “⊕” start position, it starts the engine (switch will return to on position when released). When in “○” off position, it turns engine off.
2. **Glow Plug Switch** - This “⊕” toggle switch energizes the glow plugs to aid in starting a cold diesel engine. Glow plugs are only active while switch is activated.
3. **Glow Plug Indicator Light** - This red lamp illuminates until the glow plugs have completed the timed heating cycle. When the lamp goes out, the engine is ready to be started.

2.2-10 Platform Control Console

This removable control console is mounted at the right front of the platform. It contains the following controls:

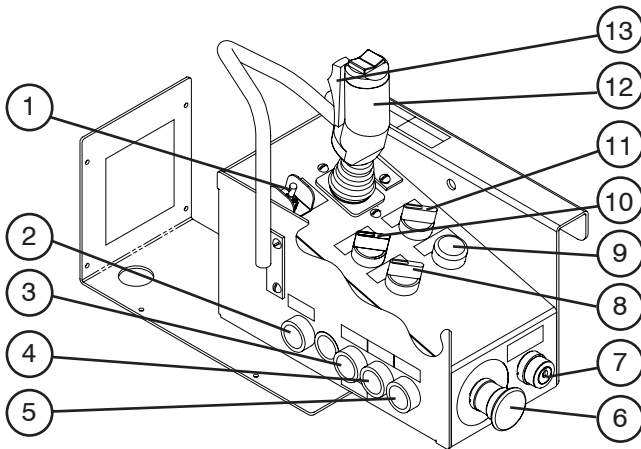

















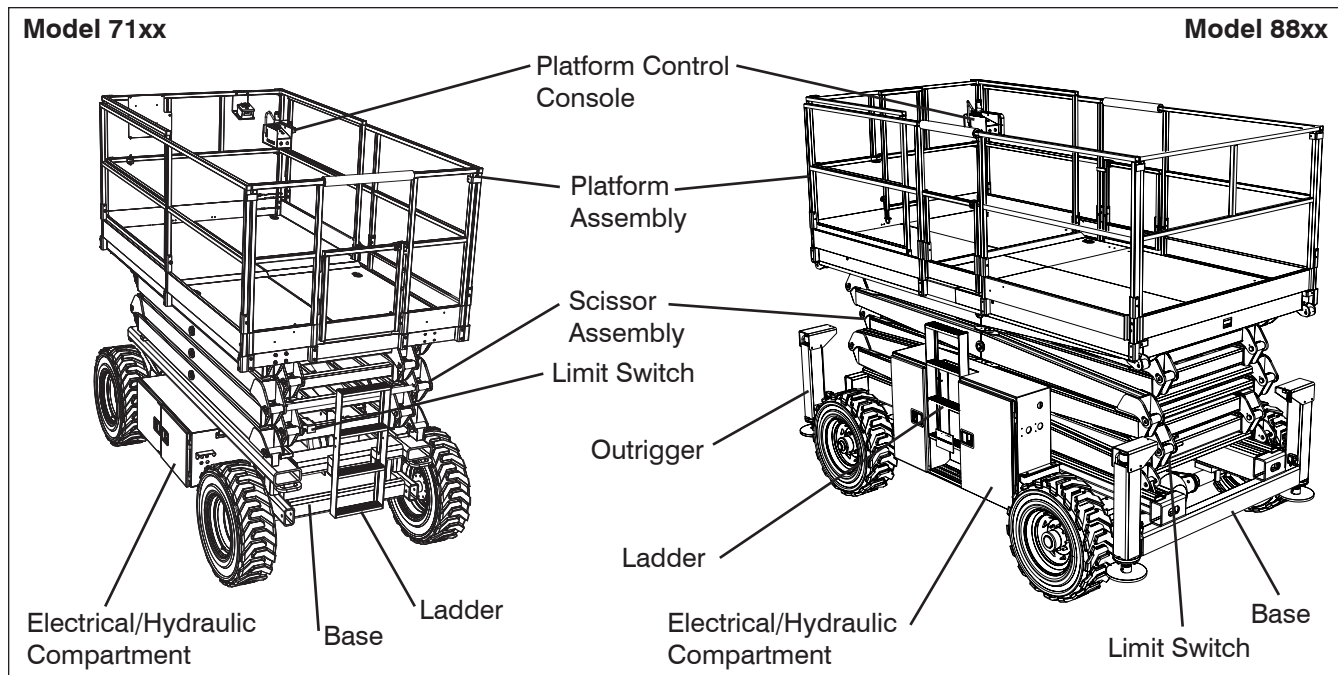

Figure 2-8. Platform Control Console

1. **Torque Switch** - This switch, when in “” high torque position, cuts out high range and 3rd speed to provide maximum torque when climbing grades and on rough terrain. When in “” low torque position, all three speeds are available.
 2. **Horn Pushbutton** - This “” pushbutton sounds an automotive-type horn.
 3. **Glow Plug Pushbutton (Diesel)** - This pushbutton energizes the “” glow plugs to aid in starting a cold diesel engine.
 4. **Engine Start Pushbutton** - This “” pushbutton energizes the engine starter motor.
- NOTE**
- The engine start pushbutton is interlocked with the oil pressure switch. If engine stalls or does not start immediately, this button will not work for a few seconds while oil pressure bleeds off.
5. **Lift Enable Pushbutton** - When depressed and held, this “” pushbutton allows the lift functions to operate.
 6. **Emergency Stop Button** - This button “”, when depressed, disconnects power to control circuit and shuts engine off. The red colored light indicates upper control availability and overload status. When the light is continuously illuminated, upper controls are available. When the light is flashing, it signals an overload function. Refer to [Section 2.2-4](#).
 7. **Off/Lift/Drive Key Switch** - Selecting “” off position disconnects power from both lift and drive circuits. Selecting “” lift position energizes the lift circuit. Selecting “” drive position energizes the drive circuit.
 8. **Raise/Off/Lower Switch** - This switch controls “” raising or “” lowering of the platform.
 9. **Operation Light** - The red colored light indicates upper control availability and overload status. When the light is continuously illuminated, upper controls are available. When the light is flashing, it signals an overload function. Refer to [Section 2.2-4](#).
 10. **Low/High Speed Range Switch** - This switch selects “” low speed range (high torque) or “” high speed range (low torque).
 11. **Low/High Throttle Switch** - This rotary switch allows selection between “” low and “” high engine throttle speeds.
 12. **Drive/Steer Controller** - This one-hand lever controls drive speed and steer motion. Internal springs return it to neutral when controller is released. The rocker switch on top of controller handle controls steering function.
 13. **Drive/Steer Enable Trigger Switch** - This momentary “” switch energizes the controller. It must be held depressed continuously while engaging either drive or steer functions.



2.3 Visual & Daily Maintenance Inspections

Begin the visual and daily maintenance inspections by checking each item in sequence for the conditions listed in this section.



WARNING

To avoid injury, do not operate an aerial platform until all malfunctions have been corrected.



WARNING

To avoid possible injury, ensure aerial platform power is off during your visual and daily maintenance inspections.

NOTE

While doing visual and daily inspections in different areas, be aware to also inspect limit switches, electrical and hydraulic components.

2.3-1 Labels

Refer to [Section 5- Labels](#) in this manual and determine that all labels are in place and are legible.

2.3-2 Electrical

Maintaining the electrical components is essential to good performance and service life of the aerial platform.

Inspect the following areas for chafed, corroded and loose wires:

- base to platform cables and wiring harness
- engine compartment electrical panel
- engine wiring harness
- hydraulic/electrical wiring harnesses

2.3-3 Limit Switches

Ensure limit switches are properly secured with no signs of visible damage and movement is not obstructed.

2.3-4 Hydraulic

Maintaining the hydraulic components is essential to good performance and service life of the aerial platform.

Perform a visual inspection around the following areas:

- hydraulic tank filter, fittings, hoses, emergency power unit (if equipped) and base surfaces
- engine compartment fittings, hoses, main pump, and filter
- all hydraulic cylinders
- all hydraulic manifolds
- the underside of the base
- ground area under the aerial platform
- outriggers

2.3-5 Emergency Lowering Access Rod (All models except 9250)

Ensure rod is properly secured and there is no visible damage.

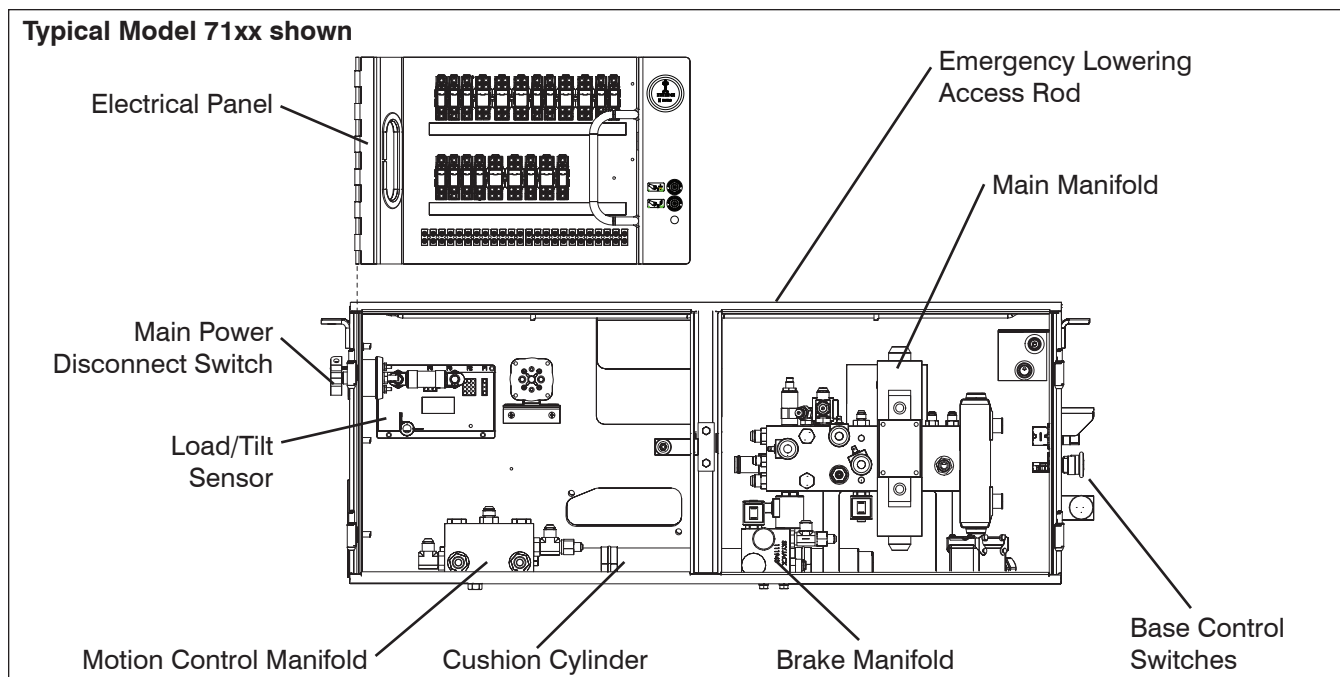

2.3-6 Hydraulic/Electrical Compartment

- Ensure all compartment latches are secure and in proper working order.
- **Main Power Disconnect Switch**
 - Turn main power disconnect switch to “○” off position.
 - Ensure all cables are secure and switch is in proper working condition.
- **Base Control Switches**
 - Ensure there are no signs of visible damage and all switches are in their neutral positions.
- **Battery**

Proper battery condition is essential to good performance and operational safety. Improper fluid levels or damaged cables and connections can result in component damage and hazardous conditions.

 **WARNING**

Battery acid is extremely corrosive - Wear proper eye and facial protection as well as appropriate protective clothing. If contact occurs, immediately flush with cold water and seek medical attention.

1. Check battery case for damage.
2. Clean battery terminals and cable ends thoroughly with a terminal cleaning tool or wire brush.
3. Ensure all battery connections are tight.
4. If applicable, check battery fluid level. If plates are not covered by at least 13 mm of solution, add distilled or demineralized water.
5. Replace battery if damaged or incapable of holding a lasting charge.

 **WARNING**

Explosion hazard. Keep flames and sparks away. Do not smoke near batteries.



 **WARNING**

Use original or manufacturer-approved parts and components for the aerial platform.

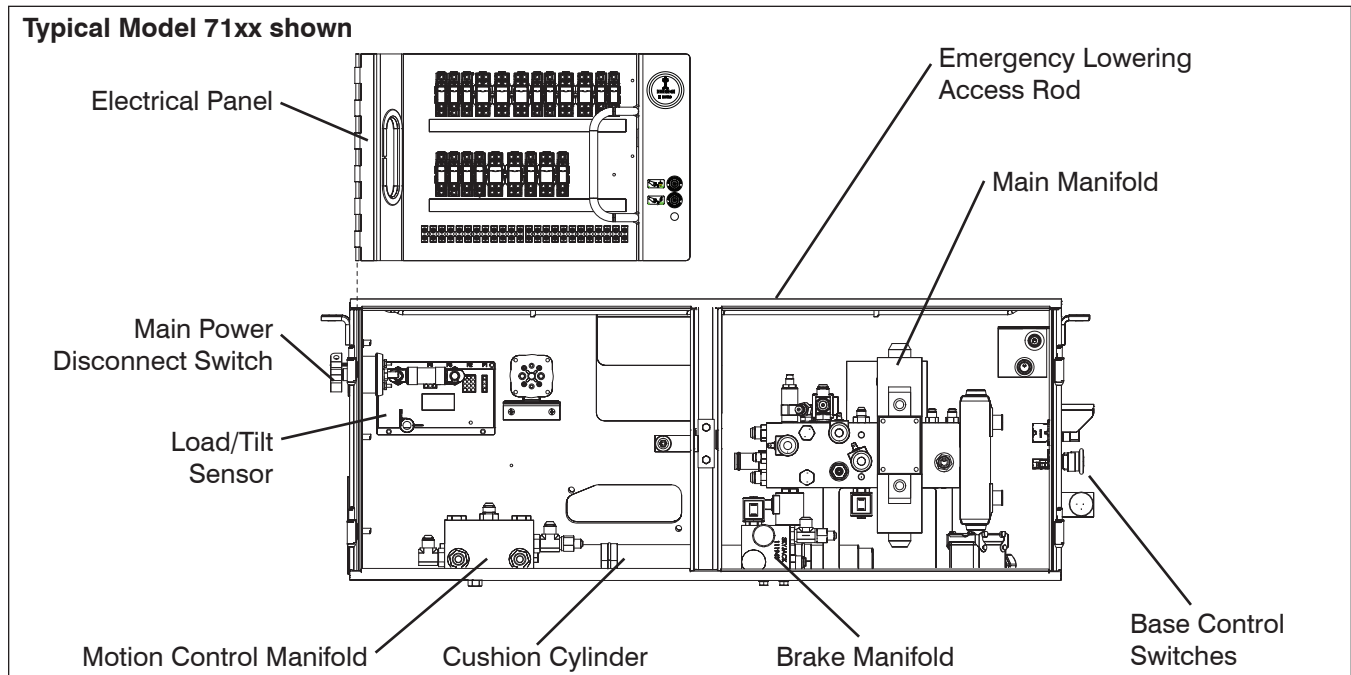

- **Manifolds**
 - Ensure all fittings and hoses are properly tightened and there is no evidence of hydraulic leakage.
 - Ensure there are no loose wires or missing fasteners.
- **Electrical Panel**
 - Ensure panel is properly secured and there is no visible damage.
 - Ensure there are no loose wires or missing fasteners.
- **Load/Tilt Sensor**
 - Ensure load/tilt sensor is properly secured and there is no visible damage.
- **Hydraulic Tank (Models 92xx)**
 - Ensure hydraulic filler cap is secure.
 - Ensure tank shows no visible damage and no evidence of hydraulic leakage.
- **Hydraulic Oil**
 - Ensure platform is fully lowered, and outriggers retracted, and then visually inspect the sight gauge located on the side of the hydraulic oil tank. Check oil level against label that indicates minimum and maximum oil levels (Models 92xx).
 - The hydraulic oil level should be at or slightly above the top mark of the sight glass (Models 71xx & 88xx).

Typical Model 71xx shown

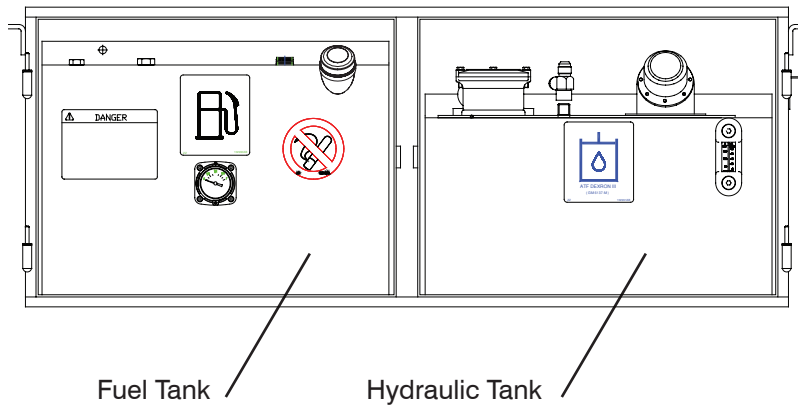

2.3-7 Hydraulic/Fuel Compartment

- Ensure all compartment latches are secure and in proper working order.
- **Hydraulic Tank (Models 71xx & 88xx)**
 - Ensure hydraulic filler cap is secure.
 - Ensure tank shows no visible damage and no evidence of hydraulic leakage.
- **Hydraulic Oil (Models 71xx & 88xx)**
 - Ensure platform is fully lowered, and then visually inspect the sight gauge located on the side of the hydraulic oil tank.
 - The hydraulic oil level should be at or slightly above the top mark of the sight glass.
- **Fuel Tank**

IMPORTANT

Before using your aerial platform ensure there is enough fuel for expected use.

- Ensure fuel filler cap is secure.
- Ensure tank shows no visible damage and no evidence of fuel leakage.

- **Fuel Leaks**

- Ensure that there no fuel leaks.



DANGER

Engine fuels are combustible. Inspect the aerial platform in an open, well-ventilated area away from heaters, sparks and flames. Always have an approved fire extinguisher within easy reach.

- Ensure fuel tank, hoses and fittings show no visible damage and no evidence of fuel leakage.

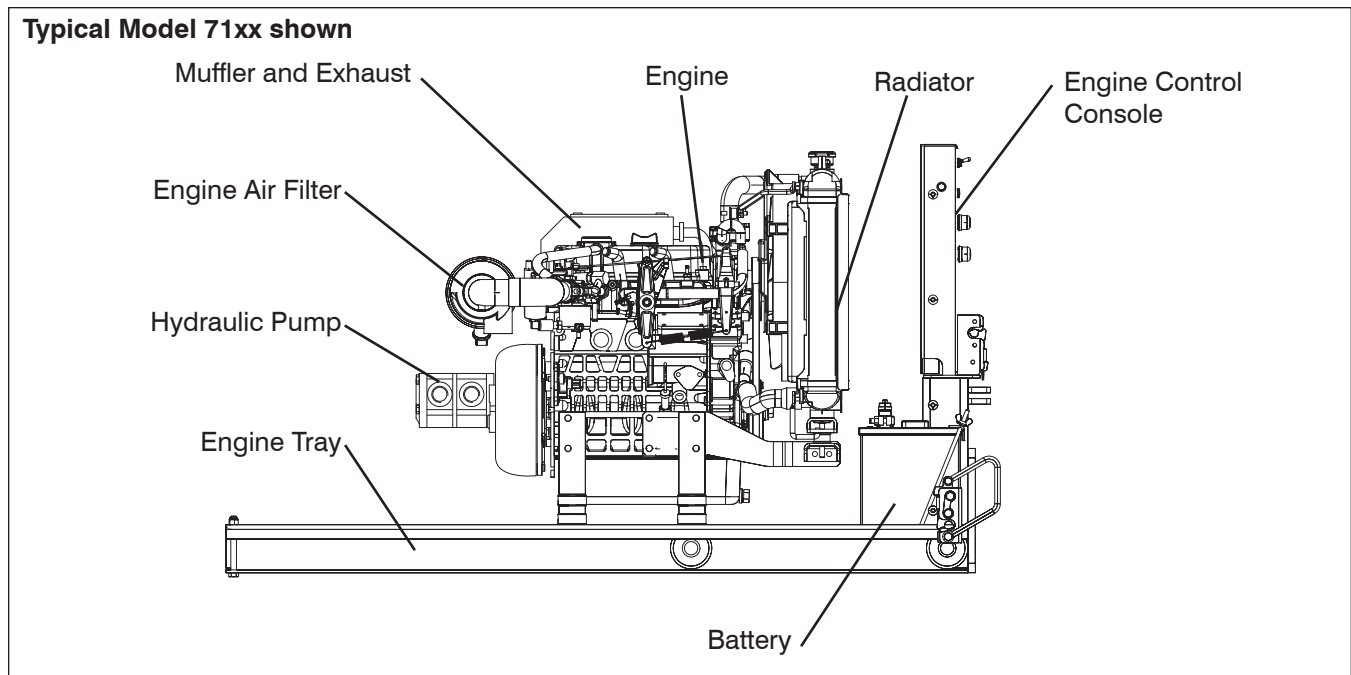

2.3-8 Engine Compartment



WARNING

Beware of hot engine components.

1. Pull on the two latches to pull out engine compartment.

- **Engine Control Console**

- Ensure muffler and exhaust system are properly secured, with no evidence of damage.

- **Radiator**

- Ensure radiator is secure.
- Ensure there are no loose or missing parts and there is no visible damage.
- Check coolant level and add as needed.

- **Muffler and Exhaust**

- Ensure muffler and exhaust system are properly secured, with no evidence of damage.

- **Engine Tray**

- Ensure there are no loose or missing parts and no visible damage to the engine tray. Ensure that both tray-securing bolts are in place.

- **Hydraulic Pump**

- Ensure there are no loose or missing parts and there is no visible damage.
- Ensure all bolts are properly tightened.
- Ensure all fittings and hoses are properly tightened and there is no evidence of hydraulic leakage.

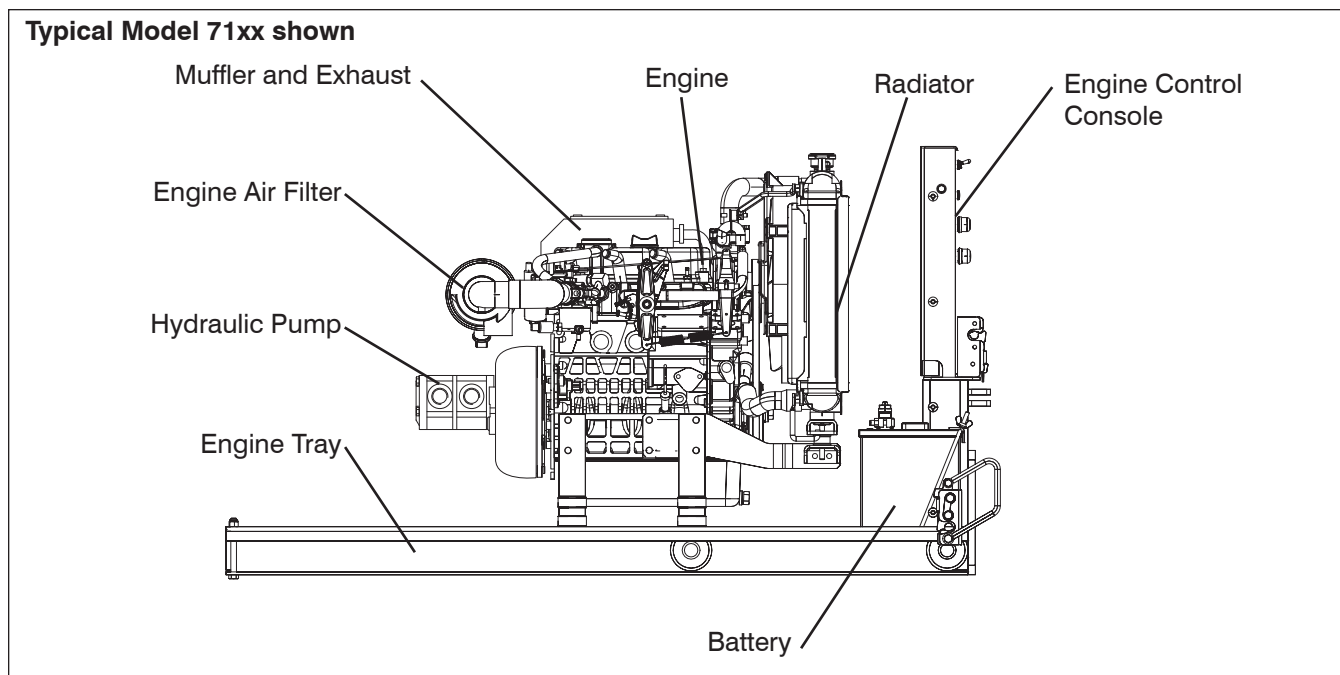

- **Engine Oil Level**
 - Maintaining the engine components is essential to good performance and service life of the aerial platform.
 - **Engine Air Filter**
 - Ensure there are no loose or missing parts and there is no visible damage.
 - **Fuel Leaks**
 - Ensure there are no fuel leaks.
- Ensure fuel pump, fuel filter, hoses and fittings show no visible damage and no evidence of fuel leakage.
2. Push in engine compartment until the two latches lock to base.

Check oil level on dipstick

- Oil level should be between the “L” and “H” marks. Add oil as needed.



DANGER

Engine fuels are combustible. Inspect the aerial platform in an open, well-ventilated area away from heaters, sparks and flames. Always have an approved fire extinguisher within easy reach.

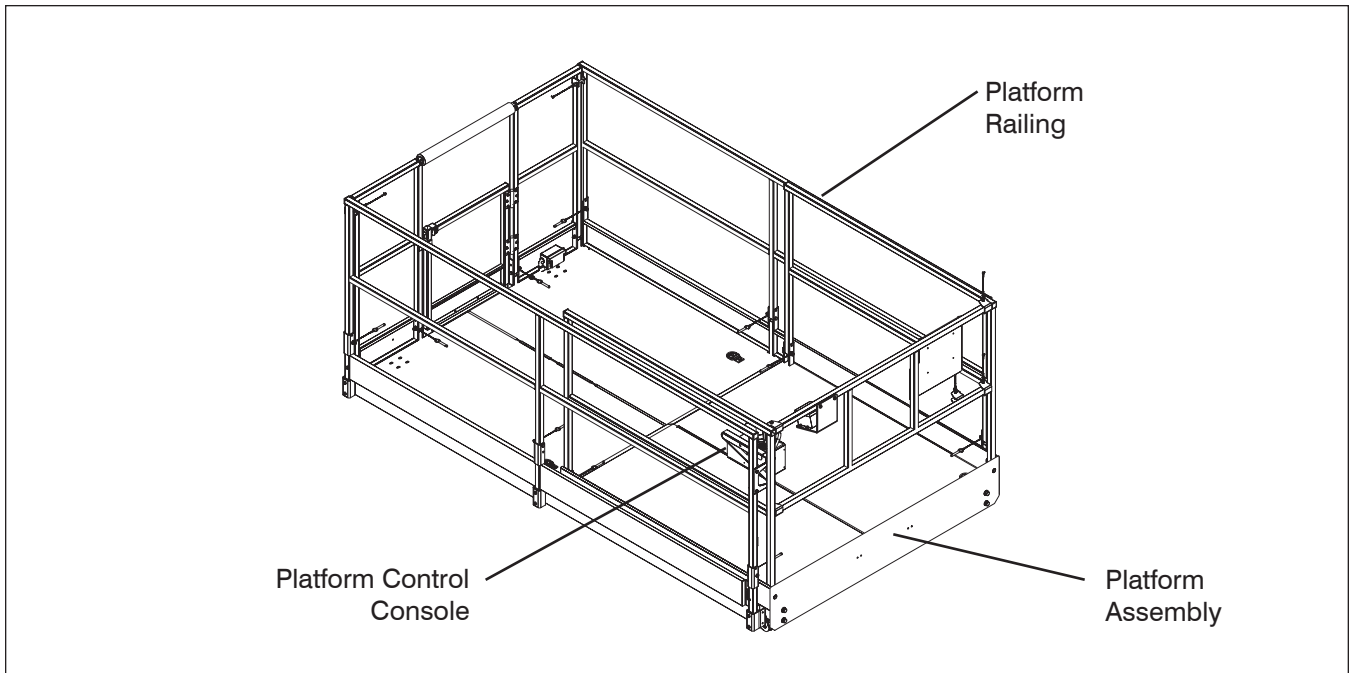

2.3-9 Platform Assembly



WARNING

Ensure that you maintain three points of contact to mount/dismount platform.

1. Use the ladder of aerial platform to access platform.
2. Close the gate.
 - Ensure there are no loose or missing parts and there is no visible damage.
 - Ensure all fasteners are securely in place.
 - Ensure all railings are properly positioned and secured.
 - Ensure gate is in good working order.
- **Lanyard Attachment Anchors**
 - Ensure attachment rings are secure and have no visible damage.
- **AC Outlet on Platform**
 - Ensure outlet has no visible damage and free from dirt or obstructions.

• **Platform Control Console**

- Ensure all switches and controller are returned to neutral and are properly secured.
- Ensure there are no loose or missing parts and there is no visible damage.

• **Powered Extension Control Console (If Equipped)**

- Ensure all switches are returned to neutral and are properly secured.
- Ensure there are no loose or missing parts and there is no visible damage.



WARNING

Ensure that you maintain three points of contact to mount/dismount platform.

3. Use the ladder to dismount from platform.

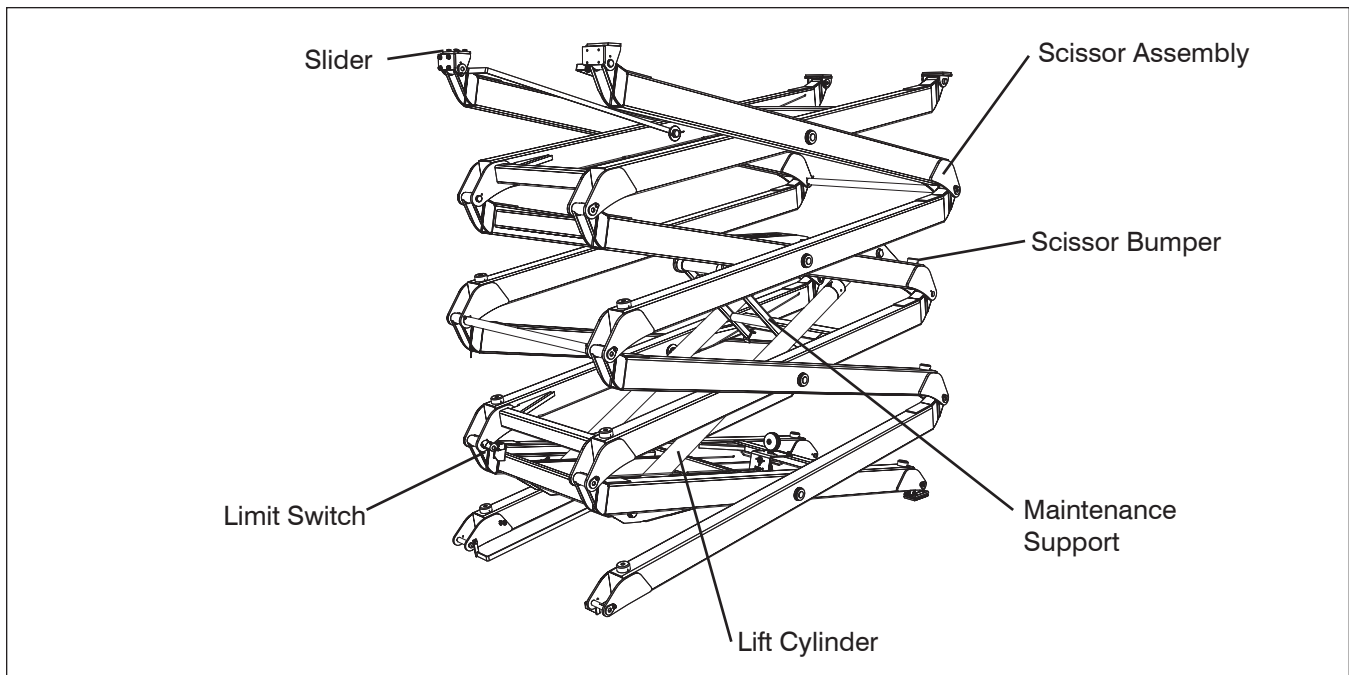

2.3-10 Lifting Mechanism

- **Scissor Guards**
 - Ensure there are no loose or missing parts and there is no visible damage.
 - **Sliders**
 - Ensure sliders are secure and there is no visible damage.
 - Ensure sliders' path of travel are free from dirt and obstructions.
1. Raise the platform (refer to [Section 3.8-2](#)) until there is adequate clearance to swing down the maintenance support (refer to [Section 3.12](#)).
- **Maintenance Support**
 - Ensure maintenance support is properly secured and shows no visible damage.
 - **Scissor Assembly**
 - Ensure scissor assembly shows no visible damage and no signs of deformation in weldments.
 - Ensure all pins are properly secured.
 - Ensure cables and wires are properly routed and shows no signs of wear and/or physical damage.

- **Scissor Bumpers**
 - Ensure bumpers are secure and shows no sign of visible damage.
 - **Lift Cylinder(s)**
 - Ensure each lift cylinder is properly secured, there are no loose or missing parts and there is no evidence of damage.
 - Ensure all fittings and hoses are properly tightened and there is no evidence of hydraulic leakage.
2. Raise the platform until there is adequate clearance to swing up the maintenance support into storage bracket. Refer to [Section 3.12](#).
 3. Fully lower the platform.

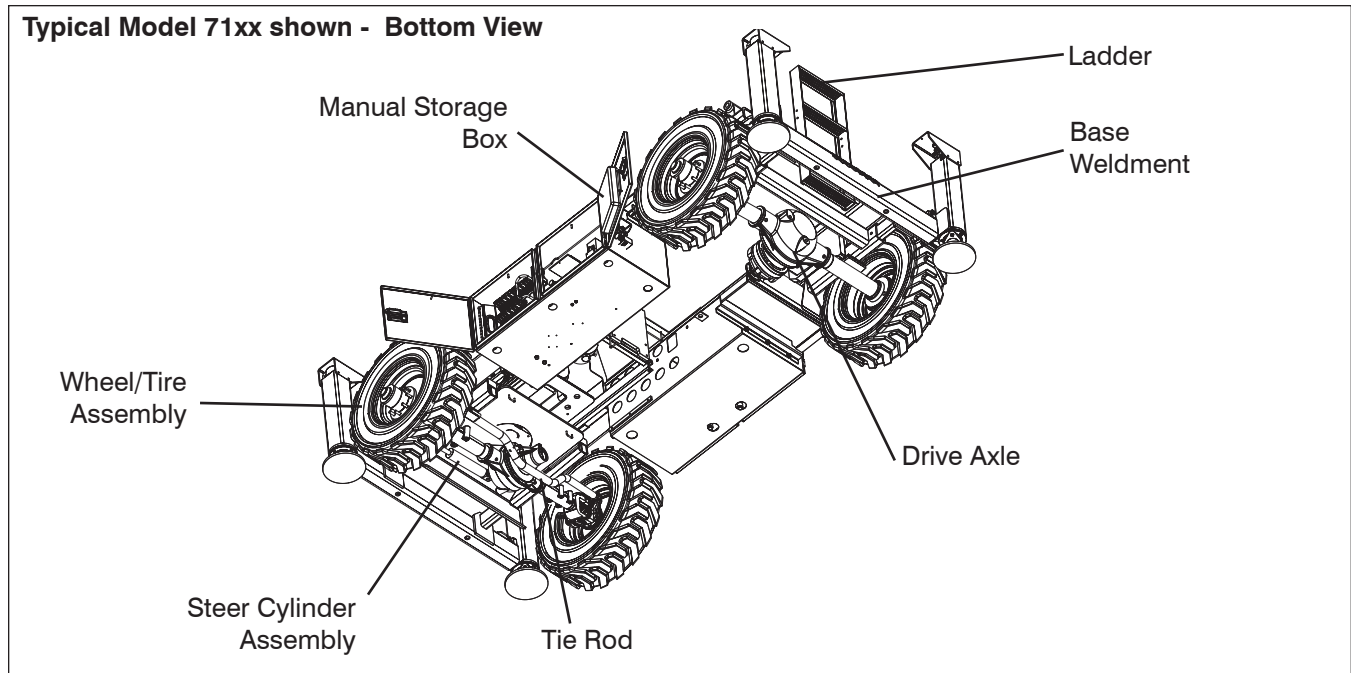

2.3-11 Base

- **Base Weldment**
 - Ensure there are no visible cracks in welds or structure and there are no signs of deformation.
- **Wheel/Tire Assembly**

The aerial platform is equipped with foam-filled tires. Tire and/or wheel failure could result in an aerial platform tipover. Component damage may also result if problems are not discovered and repaired in a timely fashion.

 - Check all tire treads and sidewalls for cuts, cracks, punctures and unusual wear.
 - Check each wheel for damage and cracked welds.
 - Check each lug nut for proper torque to ensure none are loose.
- **Drive Axle**
 - Ensure drive axle is properly secured, there are no loose or missing parts, all fittings and hoses are properly tightened and there is no evidence of hydraulic leakage.
- **Steer Cylinder Assembly**
 - Ensure steer cylinder assembly is properly secured, there are no loose or missing parts, all fittings and hoses are properly tightened and there is no evidence of hydraulic leakage.
- **Tie Rod**
 - Ensure there are no loose or missing parts, tie rod end studs are locked and there is no visible damage.

Refer to [Table 4.6](#) for wheel/tire specifications.

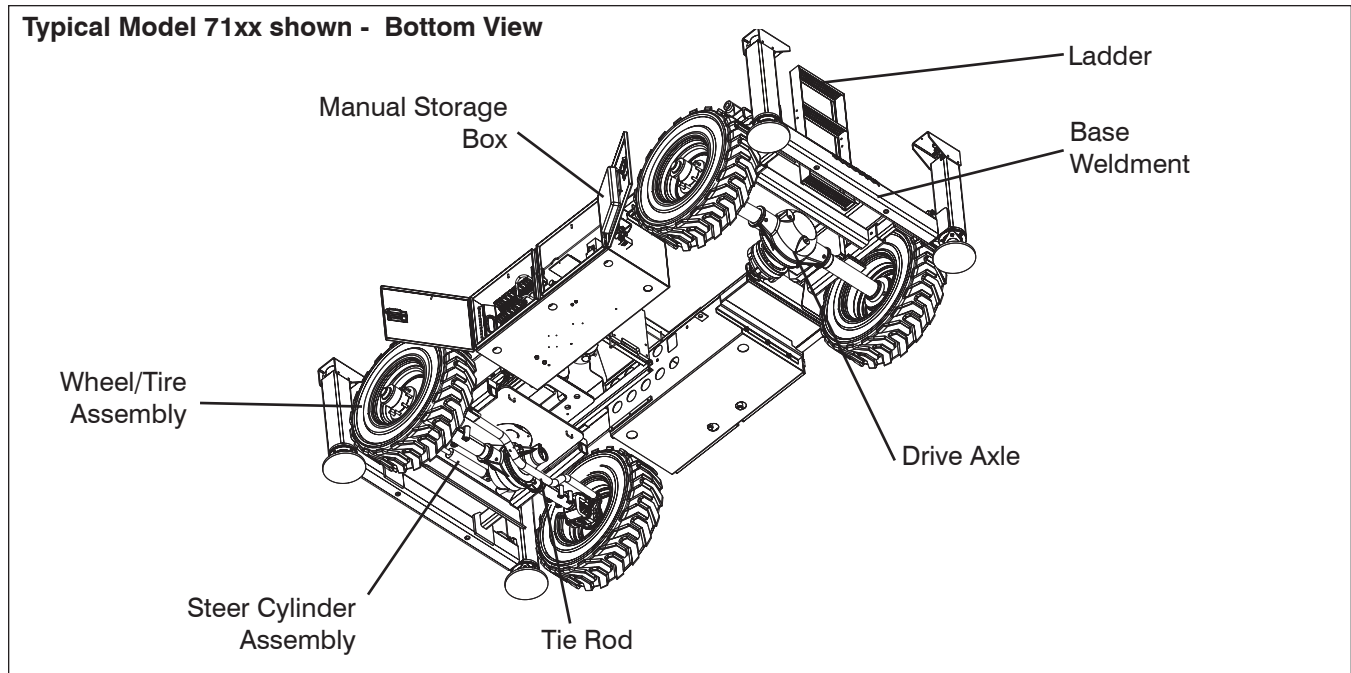

- **Ladder**
 - Ensure there are no loose or missing parts and there is no visible damage.
- **Outriggers (If Equipped)**
 - Ensure there are no loose or missing parts and there is no visible damage.

2.3-12 Manuals

Ensure a copy of operating manual is enclosed in manual storage box.

- Check to be sure manual storage box is present and in good condition.
- Ensure manuals are legible and in good condition.
- Always return manuals to the manual storage box after use.

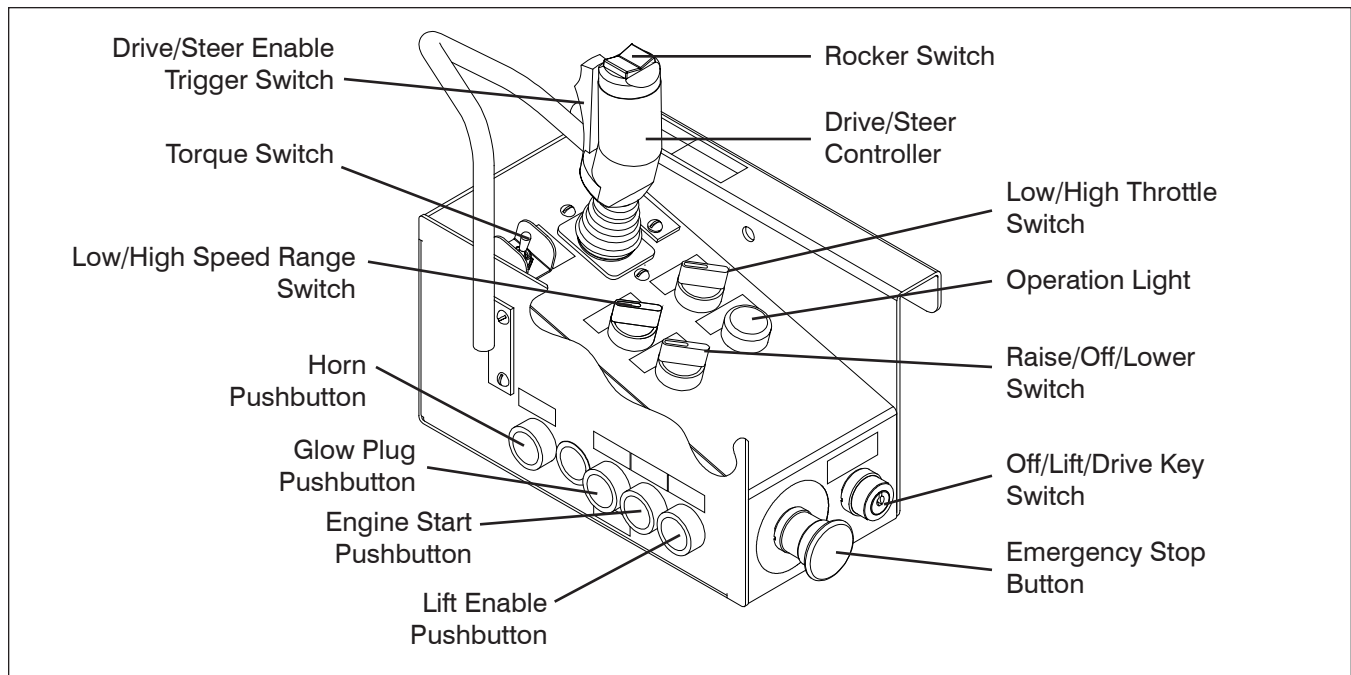

2.4 Function Tests

Function tests are designed to discover any malfunctions before aerial platform is put into service. The operator must understand and follow step-by-step instructions to test all aerial platform functions.



Never use a malfunctioning aerial platform. If malfunctions are discovered, aerial platform must be tagged and placed out of service. Repairs to aerial platform may only be made by a qualified service technician.

After repairs are completed, operator must perform a pre-operation inspection and a series of function tests again before putting aerial platform into service.



Prior to performing function tests, be sure to read and understand [Section 3.8 - Start Operation](#).

2.4-1 Platform Control Console

1. Turn main power disconnect switch to “|” on position.
2. On engine control console, select off/on/start switch to “|” on position.
3. On base control console, pull out “” emergency stop button.



Ensure that you maintain three points of contact when using the ladder to mount/dismount platform.

4. Use the ladder of aerial platform to access platform.
5. Close the gate.
6. On platform control console, insert key into off/lift/drive key switch and select “” lift position.
7. Pull out “” emergency stop button. A beeping sound should be audible and light should come on.



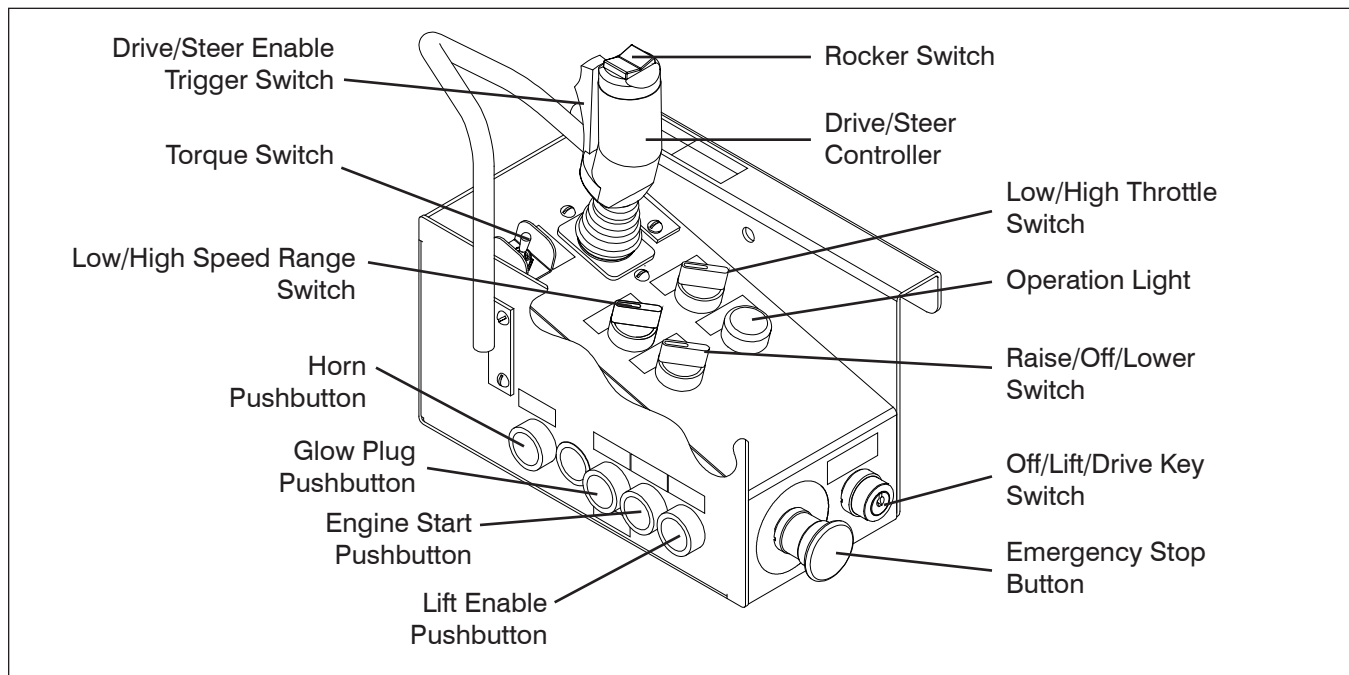

If beeping sound is not audible and light does not come on, aerial platform must be tagged and placed out of service.



- Select low/high throttle switch to “” low throttle position.



Do not start the engine in the high throttle position.



- If diesel engine is cold, depress and hold “” glow plug pushbutton for 15 to 20 seconds.
- Depress and hold “” engine start pushbutton to start the engine.

• Test Emergency Stop

- Push in “” emergency stop button.
Result: Engine should shut down and aerial platform functions should not operate.

• Test Lift Enable





- Pull out “” emergency stop button.
- Restart the engine.

- Select and hold raise/off/lower switch to “” raise position without pressing lift “” enable pushbutton.
Result: Platform should not rise.

• Test Platform Raising/Lowering





Be aware of overhead obstructions or other possible hazards around the aerial platform when lifting.

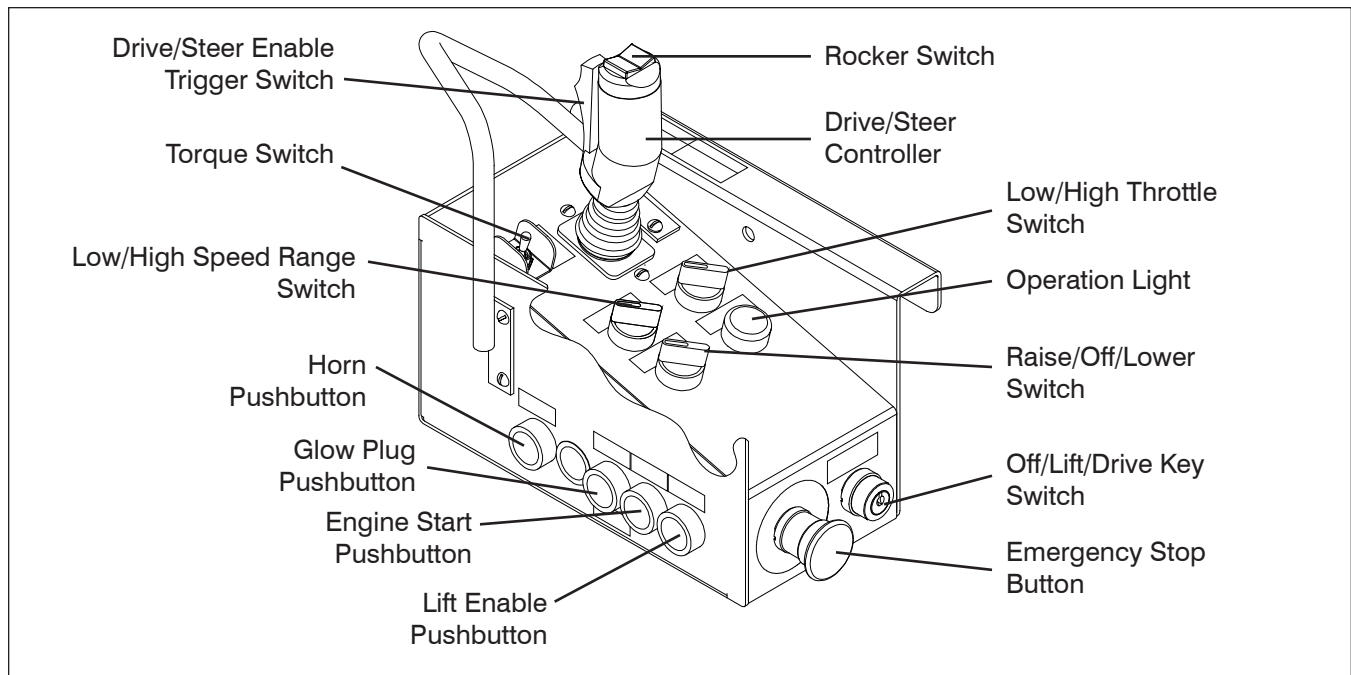

- Press and hold lift “” enable pushbutton, then select and hold raise/off/lower switch to “” raise position and raise the platform to an approximate height of 0.5 meter. Release switch to stop.
Result: Platform should rise.
- Press and hold lift “” enable pushbutton, then select and hold raise/off/lower switch to “” lower position and lower the platform fully. Release switch to stop.
Result: Platform should lower.



• **Test Enable Trigger Switch**

1. Ensure outriggers are fully retracted. Refer to [Section 3.8-10](#) for hydraulic outriggers operation.
2. Ensure path of intended motion is clear.
3. Select off/lift/drive key switch to “” drive position.
4. Without activating “” enable trigger switch, attempt to drive and steer the aerial platform.
Result: Drive and steer functions should not operate.



• **Test Steering**

1. Activate and hold enable trigger switch, and then press rocker switch on top of controller to “” left and “” right.
Result: Steer wheels should turn left and right.

• **Test Horn**

1. Push “” horn pushbutton.
Result: Horn should sound.

• **Test Driving**



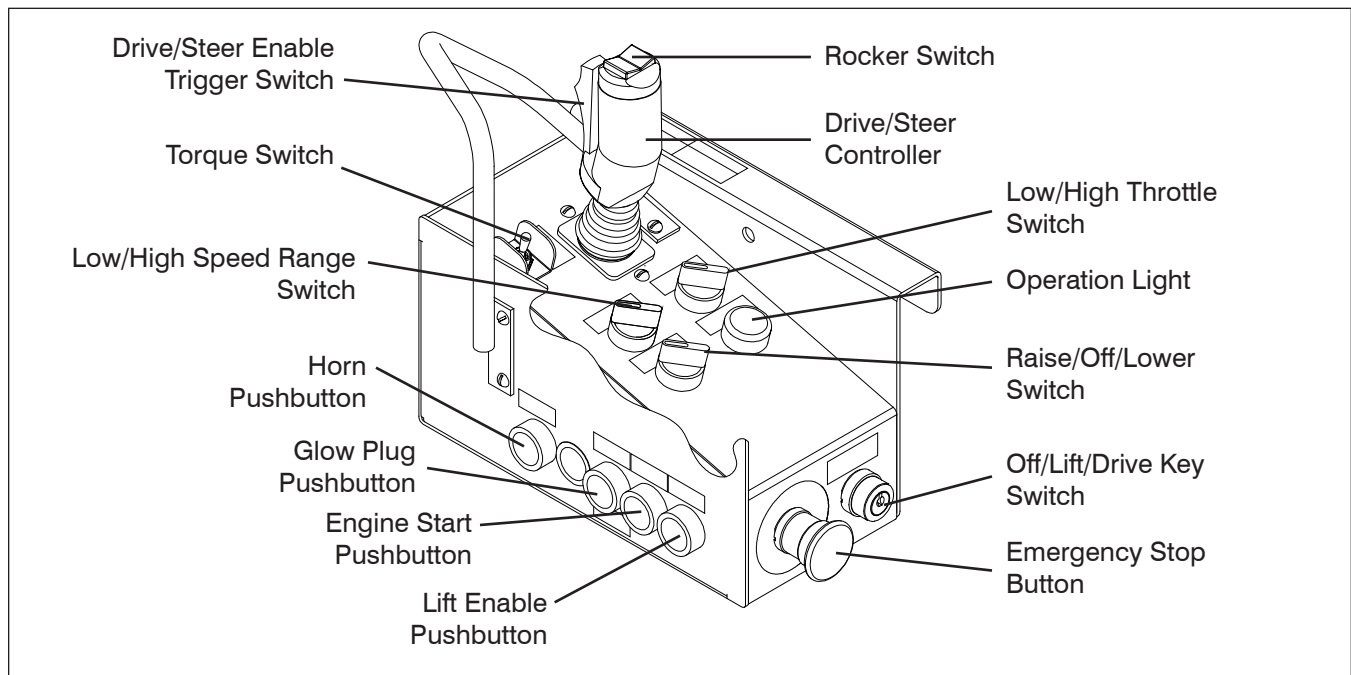

1. Ensure path of intended motion is clear.
2. Activate and hold “” enable trigger switch.
3. Slowly move controller fully “” forward, and then return handle to center position.
Result: Aerial platform should move in forward direction, and then come to a stop.
4. Slowly move controller fully “” backward, and then return handle to center position.
Result: Aerial platform should move in reverse direction, and then come to a stop.



- **Test Brake**

**WARNING**



Brake will engage instantly when controller handle is released, causing aerial platform to stop immediately.

1. Ensure path of intended motion is clear.
2. Activate and hold “” enable trigger switch.
3. Drive aerial platform “” forward. Test brake by releasing controller handle.
Result: Aerial platform should come to a stop.
4. Drive aerial platform “” forward. Test brake again by releasing “” enable trigger switch only.
Result: Aerial platform should come to an instant and abrupt stop.

- **Test Speed Limit**

**WARNING**

Be aware of overhead obstructions or other possible hazards around the aerial platform when lifting.

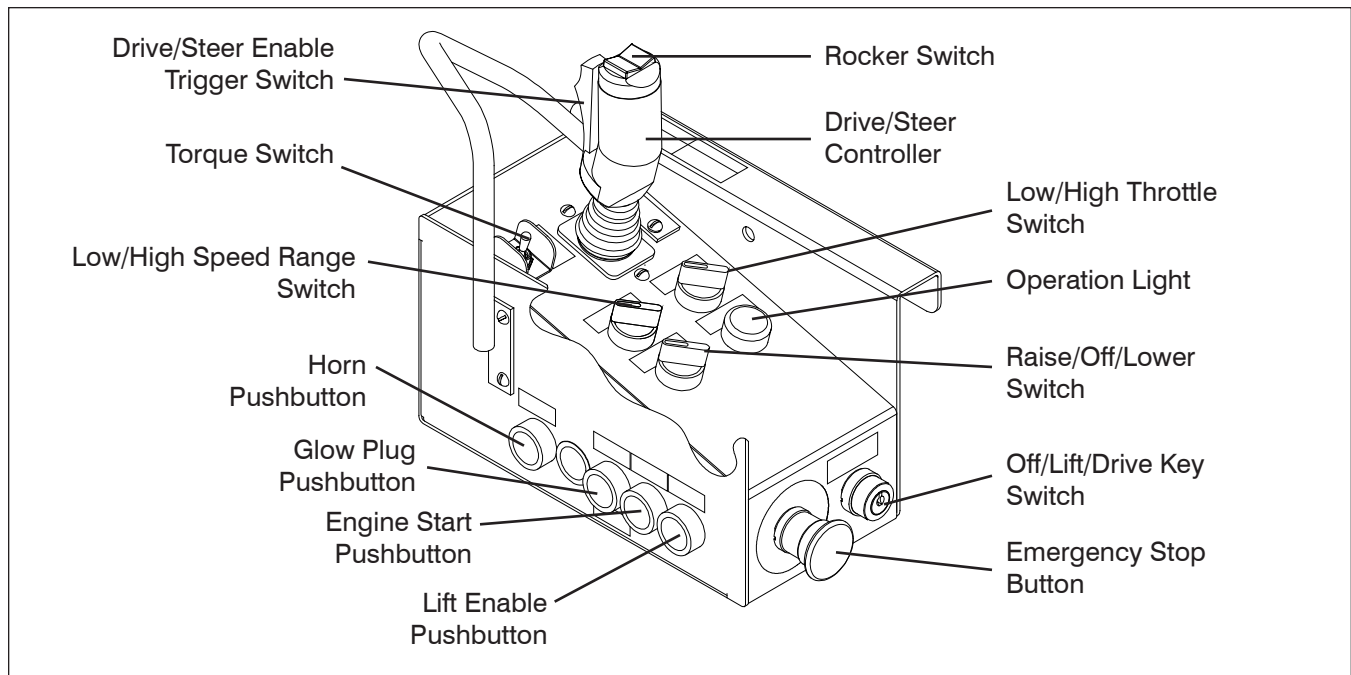

1. Ensure path of intended motion is clear.
2. Select off/lift/drive key switch to “” lift position.
3. Raise the platform to an approximate height of 4 meters.
4. Select off/lift/drive key switch to “” drive position and attempt to drive forward or reverse.
Result: Aerial platform should move slower than when it was in stowed position.



• **Test Lowering Warning**

1. Select off/lift/drive key switch to “” lift position.
2. Fully lower the platform.
Result: Alarm should sound the entire way down.

• **Test Powerdeck Enable (If Equipped)**

1. Select and hold extend/retract switch to the “” extend position without selecting “” enable switch.
Result: Platform should not extend.

• **Test Extension Platform(s) (If Equipped)**

1. Extend each extension platform to about .5 meter (refer to [Section 3.8-8](#) or [Section 3.8-9](#)).
Result: Each extension platform should extend.
2. Retract each extension platform fully.
Result: Each extension platform should fully retract.

• **Test Emergency Powered Extension Platform Retraction Switch (Models 92xx)**

1. Extend both powered extension platforms to about .5 meter.
2. Push in “” emergency stop button to shut down the engine.





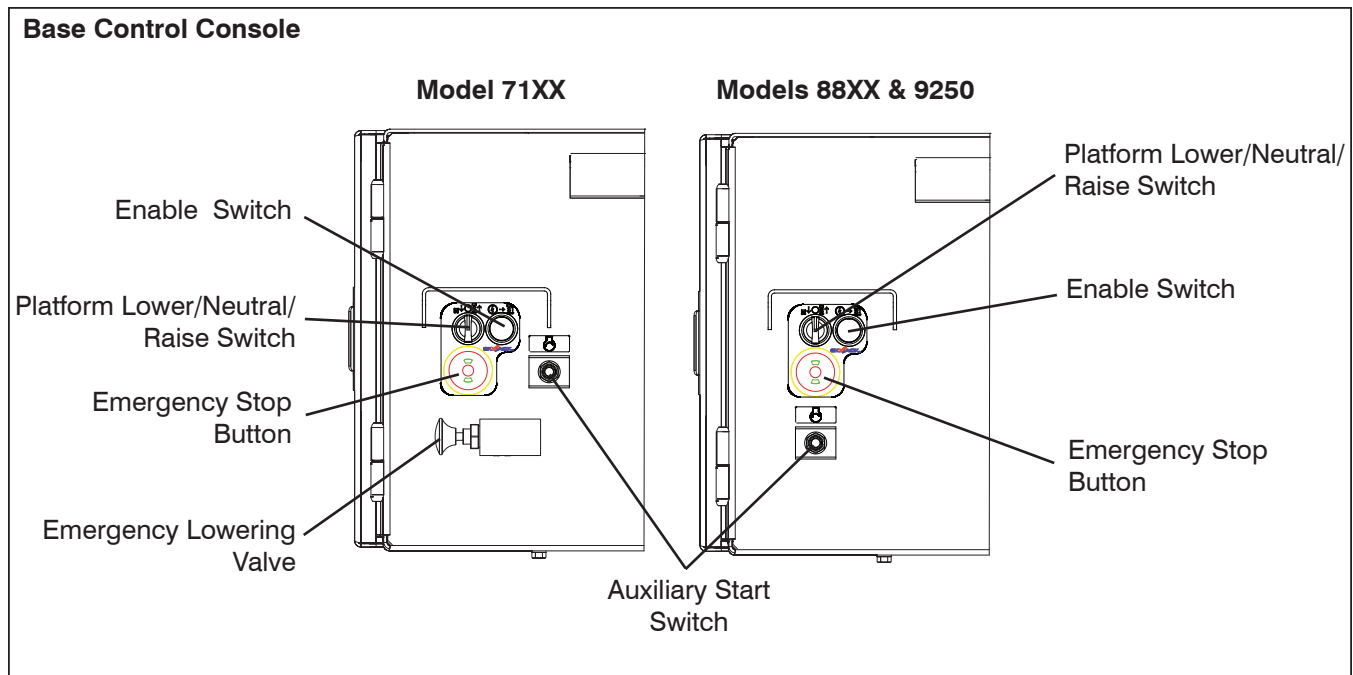

WARNING
Ensure that you maintain three points of contact when using the ladder to mount/dismount platform.

3. Use the ladder to dismount from platform.
4. On hydraulic/electric tray, push the emergency powered extension platform retraction switch.
Result: Extension platforms should retract.



2.4-2 Base Control Console

1. On engine control console, select “- **Test Emergency Stop**
 1. Push in “ - 1. On base control console, select and hold enable switch and start engine using auxiliary start switch.
Result: Engine should start.
 - 2. Release enable switch.
Result: Engine should shut off.
 - 3. Attempt to start engine without selecting and holding enable switch.
Result: Engine should not start.
- **Test Base Lift Enable**
 1. Start the engine.
 2. On base control console, select and hold lower/neutral/raise switch “↑” to raise position without selecting and holding enable switch.
Result: Platform should not rise.
- **Test Lower/Neutral/Raise Switch**
 1. On base control console, select and hold enable switch and “↑” raise the platform with lower/neutral/raise switch.
Result: Platform should rise.
 2. Select and hold enable switch and fully “↓” lower the platform with lower/neutral/raise switch.
Result: Platform should fully lower.

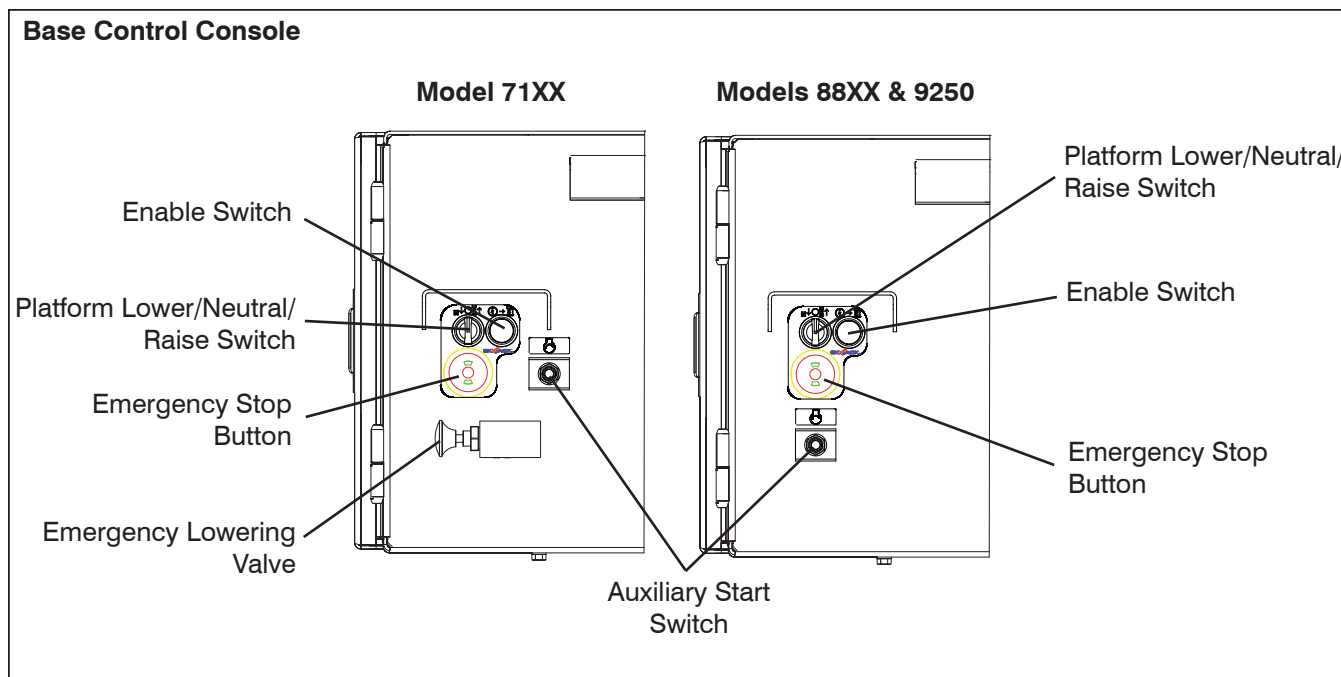

• **Test Emergency Lowering (Models 71xx & 88xx)**



WARNING
Be aware of overhead obstructions or other possible hazards around the aerial platform when lifting.

1. Raise the platform to an approximate height of 4 meters.
2. Locate holding valve manual override knob at the base of each lift cylinder. Depress and turn counterclockwise. If necessary, use emergency lowering access rod that is located either at the base, on top of scissor guards, or on top of fuel cabinet.
3. On hydraulic/electrical compartment, pull out and hold emergency lowering valve to fully lower the platform.
Result: Platform should fully lower.
4. To restore normal operation, depress and turn holding valve manual override knobs clockwise.

• **Test Emergency Lowering (Model 9250)**



WARNING
Be aware of overhead obstructions or other possible hazards around the aerial platform when lifting.

1. Raise the platform to an approximate height of 4 meters.
2. In hydraulic/electrical compartment, depress and hold emergency lowering pushbutton to activate the auxiliary lowering valves. Pull out and hold the emergency lowering valve to fully lower platform.
Result: Platform should fully lower.

2.4-3 Test Main Power Disconnect Switch

1. On hydraulic/electrical compartment, turn main power disconnect switch to “○” off position.
Result: Engine should shut down and aerial platform functions should not operate.

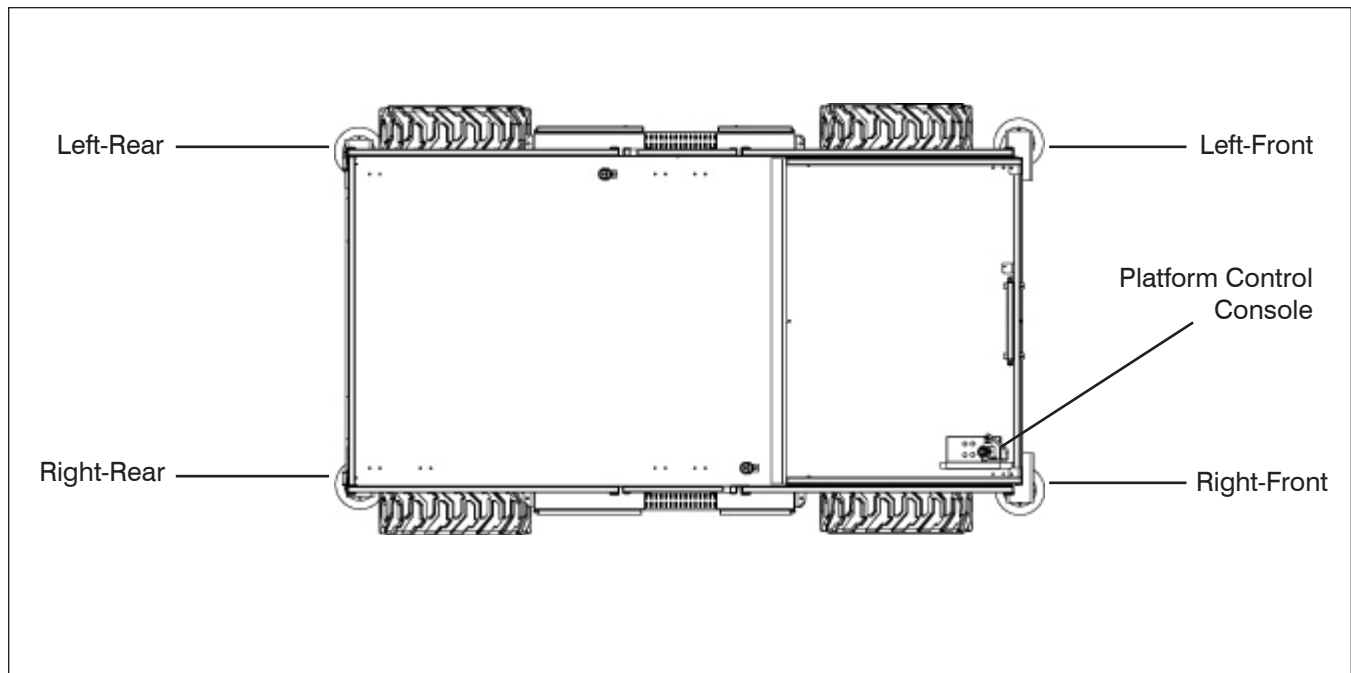

- **Test Hydraulic Outriggers (If Equipped)**
(For Hydraulic Outrigger Operation, refer to [Section 3.8-10](#))

1. Ensure aerial platform is parked on a firm level surface and free from obstructions.
2. Ensure platform is fully lowered.
3. Ensure outriggers are fully retracted.
4. Auto-level (If equipped):
Use auto-level to extend outriggers.
Result: All four outriggers will extend until they are supporting weight and bring machine to within level.
5. Once auto-level is complete, attempt to lift platform 1 foot and then lower the platform to stowed position.
Result: Platform will lift and lower.
6. With platform at stowed position, fully retract all outriggers using auto-level.
Result: All four outriggers will retract until they are in the stowed (up) position.

**WARNING**

Ensure that there are no personnel or obstructions in the path of travel, including blind spots.

7. Drive the aerial platform to maximum speed.
Result: Aerial platform drives at high speed.

**WARNING**

Be aware of overhead obstructions or other possible hazards around the aerial platform when lifting or driving.

8. Lift platform to 12 feet (measured from the bottom of the tires to the platform surface) from stowed position.
Result: Lift function will operate.
9. Drive aerial platform at raised height (12 feet).
Result: Aerial platform drives at slow speed.
10. Attempt to operate outriggers at raised height (12 feet).
 - Attempt to partially extend Left-Front Outrigger (approximately 4").
Result: Outrigger will not extend.
 - Attempt to partially extend Right-Front Outrigger (approximately 4").
Result: Outrigger will not extend.

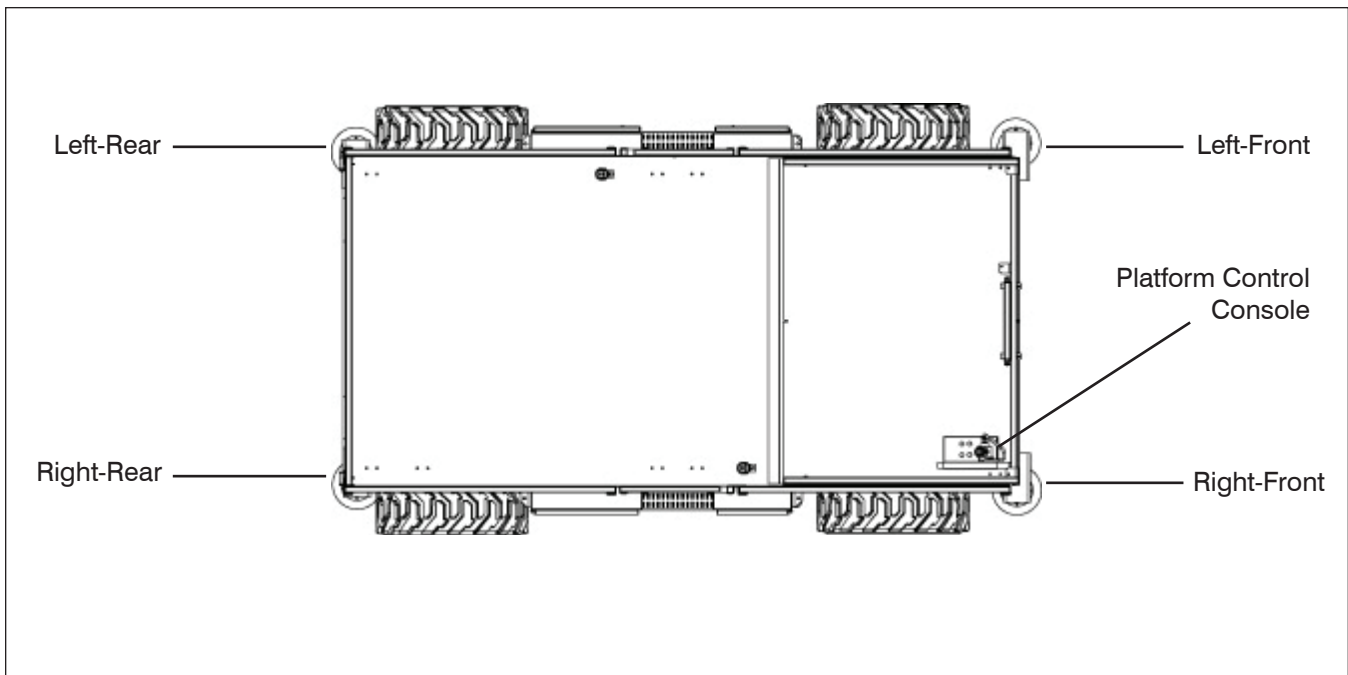

- Attempt to partially extend Right-Rear Outrigger (approximately 4").
Result: Outrigger will not extend.
- Attempt to partially extend Left-Rear Outrigger (approximately 4").
Result: Outrigger will not extend.
- With Right-Rear Outrigger partially extended, attempt to lift the platform.
Result: Lift function will not operate.
- With Left-Rear Outrigger partially extended, attempt to lift the platform.
Result: Lift function will not operate.

11. Lower the platform to stowed position.
Result: Lower function will operate.

12. Raise the platform 1 foot from stowed position and partially extend Left-Front Outrigger (approximately 4").

- Attempt to lift the platform.
Result: Lift function will not operate.

- Attempt to drive the aerial platform.
Result: Drive function will not operate.
- Attempt to lower the platform.
Result: Lower function will operate.

13. Platform at stowed position.

- With Left-Front Outrigger partially extended, attempt to lift the platform.
Result: Lift function will not operate.
- With Right-Front Outrigger partially extended, attempt to lift the platform.
Result: Lift function will not operate.

14. Platform at stowed position.

- Extend each outrigger until it raises the tires up approximately 2".

- Retract the Left-Front Outrigger until the weight is resting on the corresponding tire.
- Extend the Right-Rear Outrigger until it makes contact with ground.
- Attempt to lift the platform 1 foot.
Result: Lift function will not operate.

15. Platform at stowed position.

- Extend each outrigger until it raises the tires up approximately 2".

- Retract the Right-Front Outrigger until the weight is resting on the corresponding tire.
- Extend the Left-Rear Outrigger until it makes contact with ground.

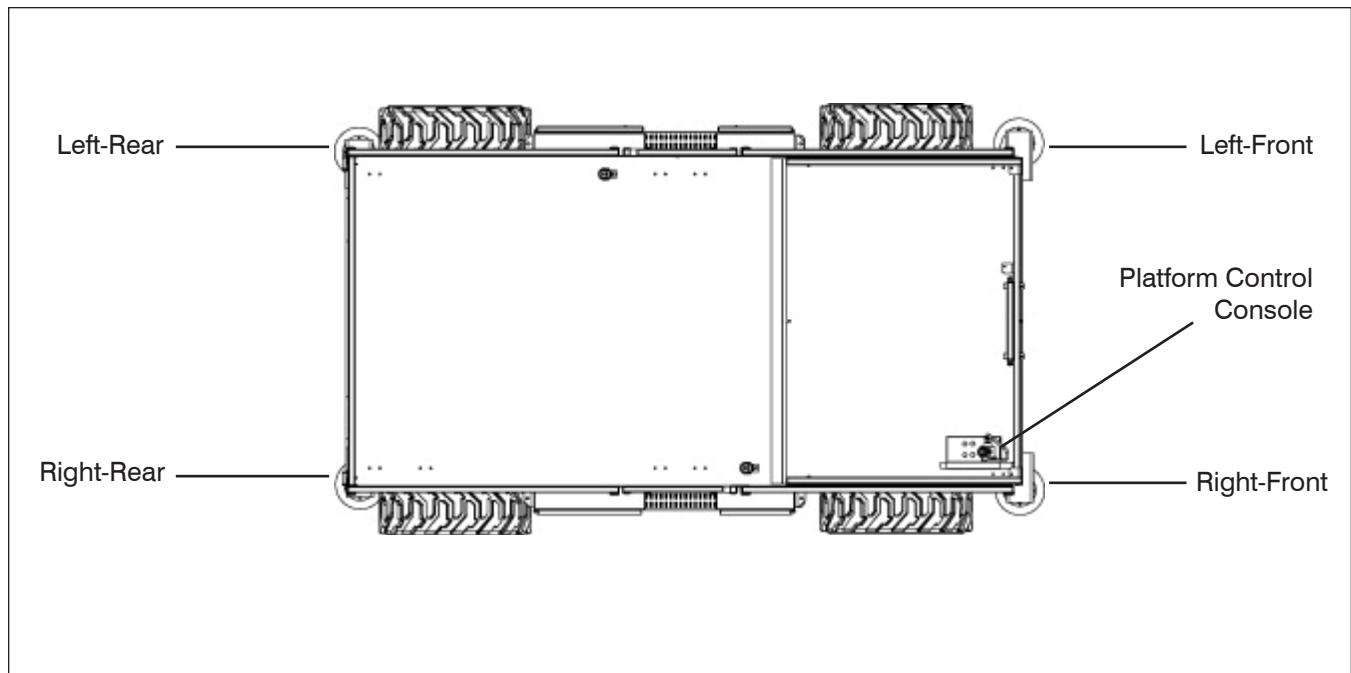

- Attempt to lift the platform 1 foot.
Result: Lift function will not operate.
16. Platform at stowed position.
- Extend each outrigger until it raises the tires up approximately 2".
 - Retract the Right-Rear Outrigger until the weight is resting on the corresponding tire.
 - Extend the Left-Front Outrigger until it makes contact with ground.
 - Attempt to lift the platform 1 foot.
Result: Lift function will not operate.
17. Platform at stowed position.
- Extend each outrigger until it raises the tires up approximately 2".
 - Retract the Left-Rear Outrigger until the weight is resting on the corresponding tire.
 - Extend the Right-Front Outrigger until it makes contact with ground.
 - Attempt to lift the platform 1 foot.
Result: Lift function will not operate.
18. Extend all four outriggers until all tires are off the ground and the aerial platform is levelled.
- Lift the platform to 12 feet.
Result: Lift function will operate.
 - Lower the platform from raised height (12 feet).
Result: Lower function will operate.

**WARNING**

If any outrigger interlocks fail to operate in the expected manner, the aerial platform should be tagged and removed from operation immediately.

**WARNING**

Repairs to the aerial platform may only be made by a qualified service technician.

2.5 Winching and Towing Procedure

This section provides the operator with procedures regarding winching, towing and manual brake release.

WARNING

Ensure platform is fully lowered before winching or towing. Sudden motion could cause aerial platform to become unstable. Death or serious injury could result.

WARNING

In emergency situations where aerial platform functions are not available and lowering is impeded by an obstacle, utmost care must be taken to move aerial platform far enough to clear obstacle. In such cases, operation must be extremely smooth with no sudden movements and must not exceed a speed of 50 mm/sec.

WARNING

When pushing, winching or towing, do not exceed 3.2 km/h.

WARNING

Do not push, winch or tow aerial platform onto a slope. Do not stop the towing vehicle rapidly. Do not pull aerial platform down an incline.

2.5-1 To Release the Brake Manually

WARNING

Do not manually disengage brake if the aerial platform is on an incline.

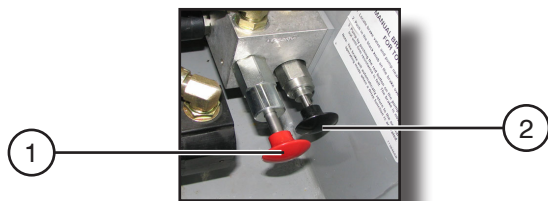

Figure 2-9. Brake System

1. Brake Hand Pump
2. Brake Auto Reset Valve Plunger

WARNING

Brake must be manually disengaged before pushing, winching or towing.

1. Ensure aerial platform is on level ground. Chock or block wheels to prevent aerial platform from rolling.
2. Turn main power disconnect switch to “O” off position.
3. Locate the manifold in hydraulic/electrical compartment.
4. Push in brake auto reset valve plunger (item 2).
5. Repeatedly depress hand pump (item 1) until firm resistance is felt. The brake is now released.
6. Remove wheel chocks or blocks then push, winch or tow aerial platform to desired location.

WARNING

Brake must be reengaged immediately after reaching desired location.

7. Position aerial platform on a firm and level surface.
8. Chock or block wheels to prevent aerial platform from rolling.
9. Reengage brake by pulling out brake valve plunger.

2.6 Emergency Lowering Procedures

This section guides the operator on how to use the emergency lowering system. This system allows platform lowering in the event of an emergency or malfunction.

Models 71xx & 88xx



WARNING

Keep clear of scissors mechanism when using emergency lowering valve.

1. Remove any obstructions to a descending platform.
2. Extension platform(s) may need to be retracted or aerial platform may need to be moved to clear obstructions. Refer to [Section 2.5](#) for winching and towing procedures.

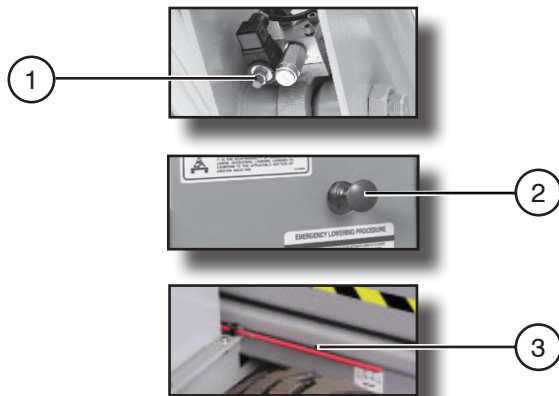

Figure 2-10. Emergency Lowering System

3. Locate holding valve override knobs (item 1) at base of each lift cylinder. Depress and turn counterclockwise. If necessary, use emergency lowering access rod (item 3) that is located on aerial platform base or on top of fuel cabinet.
4. On the hydraulic compartment, pull out and hold emergency lowering valve (item 2) to lower platform.
5. To restore normal operation, depress and turn holding valve override knobs clockwise.

Model 9250



WARNING

Keep clear of scissors mechanism when using emergency lowering valve.

1. Remove any obstructions to a descending platform.



WARNING

Ensure platform and extensions including railing are clear of obstructions before operating emergency powered extension platform retraction switch.

2. Extension platform(s) may need to be retracted or aerial platform may need to be moved to clear the obstructions. Refer to [Section 2.5](#) winching and towing procedures. Models 92xx are equipped with emergency powered extension platform retraction switch (located in the hydraulic/electrical compartment) to retract the powered extension platform from the base.



Figure 2-11. Emergency Powered Extension Platform Retraction Switch

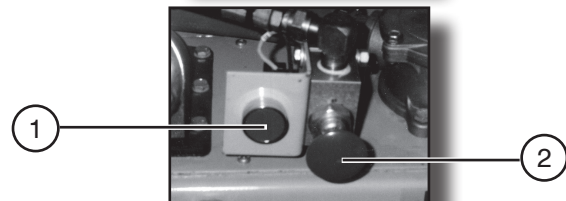
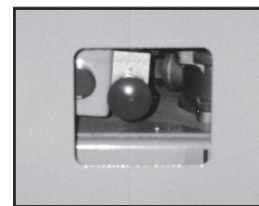

Figure 2-12. Emergency Lowering System

3. In hydraulic compartment, depress and hold emergency lowering pushbutton (item 1) to activate the auxiliary lowering valves. Pull out and hold the emergency lowering valve (item 2) to lower platform. No further actions are required to restore normal operation.

3.0 Operation

This section provides the necessary information needed to operate the aerial platform. It is important that the user reads and understands this section before operating the aerial platform.

3.1 General

In order for this aerial platform to be in good working condition, it is important that the operator meets the necessary qualifications and follow the maintenance and inspection schedule referred to in this section.

3.1-1 Operator Qualifications

- Only trained and authorized personnel shall be permitted to operate an aerial platform.
- Safe use of this aerial platform requires the operator to understand the limitations and warnings, operating procedures and operator's responsibility for maintenance. Accordingly, the operator must understand and be familiar with this operating manual, its warnings and instructions, and all warnings and instructions on the aerial platform.
- The operator must be familiar with employer's work rules and related government regulations and be able to demonstrate the ability to understand and operate this make and model of aerial platform in the presence of a qualified person.

3.1-2 Operator's Responsibility for Maintenance



WARNING

Maintenance must be performed by trained and competent personnel who are familiar with mechanical procedures.

Death or serious injury could result from the use of an aerial platform that is not properly maintained or kept in good working condition.

- The operator must be sure that the aerial platform has been properly maintained and inspected before using it.
- The operator must perform all the daily inspections and function tests found in [Table 4.8](#), even if the operator is not directly responsible for the maintenance of this aerial platform.

3.1-3 Maintenance and Inspection Schedule

- The inspection points covered in [Table 4.8](#) indicate the areas of the aerial platform to be maintained or inspected and at what intervals the maintenance and inspections are to be performed.
- The actual operating environment of the aerial platform may affect the maintenance schedule.



WARNING

Use original or manufacturer-approved parts and components for the aerial platform.

3.1-4 Owner's Inspections

It is the responsibility of the owner to arrange daily, quarterly (or 150 hours) and annual inspections of the aerial platform. Refer to [Table 4.8](#) for recommended maintenance and inspection areas and intervals. A record of annual inspection is kept on a label located on the scissor assembly. Refer to [Table 4.2](#) in this manual.

3.2 Major Components

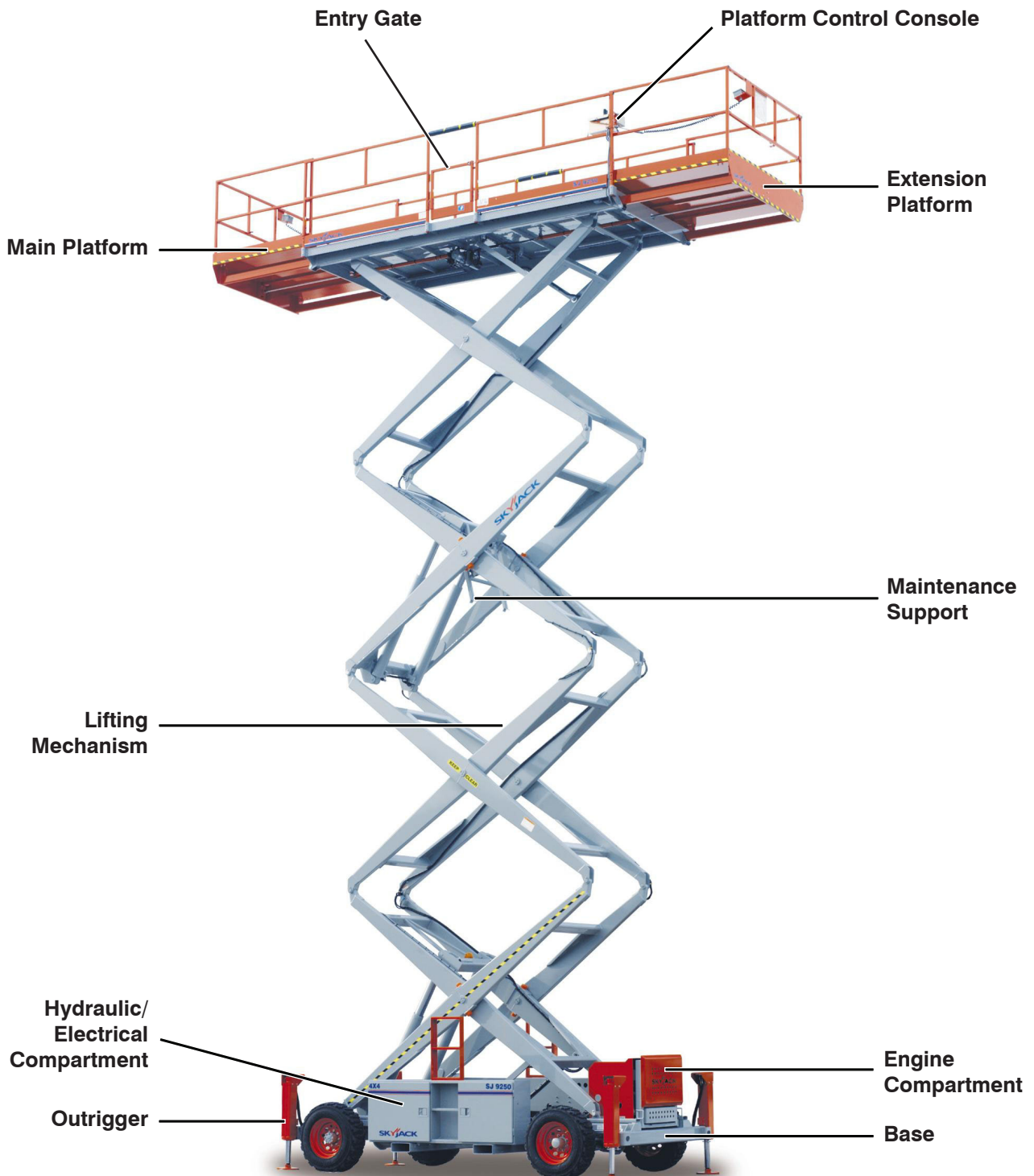

SKYJACK Model 7127 Aerial Platform

3.3 Major Assemblies

The aerial platform consists of three major assemblies: base, lifting mechanism and platform.

3.3-1 Base

The base is a rigid, one-piece weldment which supports two side compartments.

Models 71xx & 88xx

- One compartment contains the hydraulic and electrical components, and base control console. The other compartment contains the fuel and hydraulic tanks.
- The front axle is steered by a hydraulic cylinder and is either non-driven (2WD) or drive shaft/gear box driven (4WD).
- The rear axle is drive shaft/gear box driven and has a spring-applied hydraulically released disc brake.
- A roll-out tray at the front of the base supports an engine coupled with a two-section hydraulic pump providing power to the hydraulic system.
- An engine control console is also located at the front of the base.
- The 12V starter battery is located in the hydraulic/electrical compartment or at the front of the engine roll-out tray.

Models 92xx

- One compartment contains the hydraulic tank, hydraulic and electrical components, base control console, emergency battery and starter battery.
- The other compartment contains the fuel tank.
- The front axle is steered by a hydraulic cylinder and is drive shaft/gear box driven (4WD).
- The rear axle is drive shaft/gear box driven and has a spring-applied hydraulically released disc brake.
- A roll-out tray at the front of the base supports an engine coupled with a two-section hydraulic pump providing power to the hydraulic system.
- An engine control console is also located at the front of the base.

3.3-2 Lifting Mechanism

The lifting mechanism is constructed of formed steel or tube sections making up a scissor-type assembly. The scissor assembly is raised and lowered by single-acting hydraulic lift cylinders with holding valves. A two-section pump, driven by an engine, provides hydraulic power to the lift cylinders.

3.3-3 Platform

The platform is constructed of a tubular support frame, a skid-resistant “diamond plate” platform surface and 1.1 m hinged guardrails with 0.15 m toe boards and mid-rails. The platform can be entered from either side through a spring-returned gate for full size RTs and from the rear through a spring-returned gate for mid size RTs. Some full size RTs can be equipped with a front or rear (or both) extension platform(s). The mid size RTs are equipped with a front extension platform. Models 92xx are equipped with two powered extension platforms. An AC outlet is also located on the platform.

3.4 Serial Number Nameplate

The serial number nameplate, located at the rear of the aerial platform, lists the following:

- Model number
- Serial number
- Aerial platform weight
- Maximum drivable height
- Maximum capacities
- Maximum number of persons permissible on the platform
- Voltage
- System pressure
- Lift pressure
- Maximum platform height
- Maximum wheel load
- Maximum wind speed
- Maximum manual force
- Maximum incline
- Year of manufacture

3.5 Component Identification

The following descriptions are for identification, explanation and locating purposes only.

3.5-1 Manual Storage Box

This weather-resistant box is mounted inside of the hydraulic/ electrical compartment. It contains the operating manual, EC declaration and other important documentation. The operating manual for this make and model of aerial platform must be stored in this box.



3.5-2 Maintenance Support

The maintenance support is a safety mechanism designed to support the scissor assembly. When properly positioned, it can support the scissor assembly and empty platform. The maintenance support must be used when inspection and/or maintenance is to be performed within the lifting mechanism. To lower the maintenance support, push lock lever rearward and the maintenance support will drop. Refer to Section 3.12 for procedure on how to use and store the maintenance support.

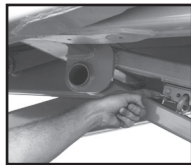

Figure 3-1. Maintenance Support



WARNING

The maintenance support must be used when inspection and/or maintenance or repairs are to be performed within the lifting mechanism. Failure to use this safety mechanism could result in death or serious injury.



WARNING

Do not reach through the scissor assembly when the platform is raised without the maintenance support properly positioned. Failure to avoid this hazard could result in death or serious injury.

3.5-3 Electrical Control Console

This auxiliary control console is located in the hydraulic/ electrical compartment. It contains the following controls:

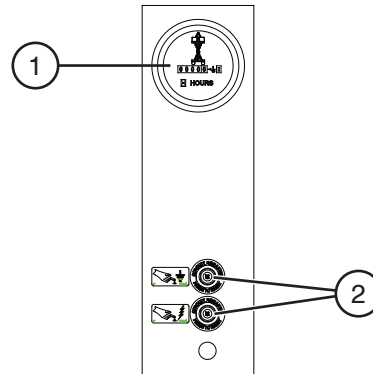

Figure 3-2. Electrical Control Console

1. **Hourmeter** - This gauge records accumulated operating time of engine.
2. **Circuit Breakers** - In the event of a power overload or positive circuit grounding, the circuit breaker pops out. Push breaker back in to reset.

3.5-4 Folding Guardrail System

This system, when folded down, reduces the height of the retracted aerial platform for transporting and traveling through doorways only. Refer to [Section 3.11](#) for guardrail folding procedure.

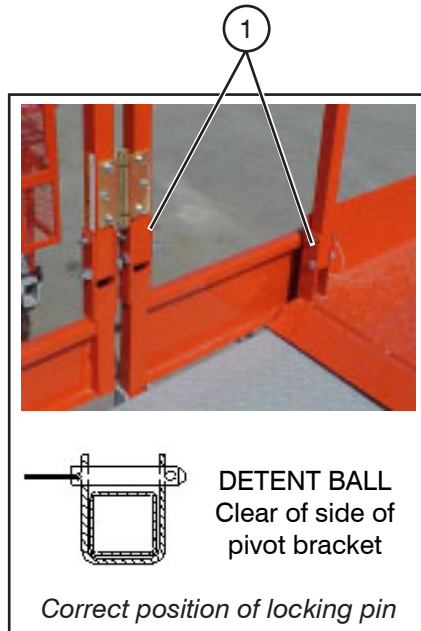

Figure 3-3. Guardrail Locking Pin



WARNING

The scissor assembly must be fully lowered before raising or lowering the guardrails.



WARNING

Before operating this aerial platform check the guardrail system for loose or missing locking pins. The guardrail system must be upright and all pins must be locked in place. Death or serious injury could result if the guardrail system is not upright or properly locked.

3.5-5 Lanyard Attachment Anchorage

Use this as an attachment point for safety belt/harness tethers. Do not attach belts/harnesses to any other point on the platform. Do not use this point to lift, anchor, secure or support the platform or any other apparatus or material.



Figure 3-4. Lanyard Attachment Ring



WARNING

The lanyard attachment anchorage is used for travel restraint, within the limits of the platform only. It is not a fall arresting device! Used as such could result in death or serious injury.

3.6 Component Identification (Special Options)

This following descriptions are for identification, explanation and locating purposes only of optional equipment.

3.6-1 Generator/Outrigger Control Console (If Equipped)

The outrigger control console are located next to the platform control console. These switches control the outriggers' extension and retraction.

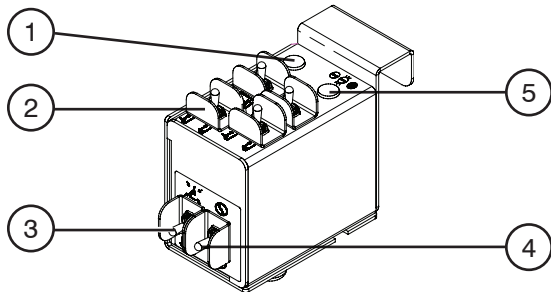

Figure 3-5. Outrigger Controls with All Options on Auxiliary Control Console

1. **Generator Switch** - This switch activates the generator.
2. **Outrigger Extend/Retract Switches** - These switches control the extension and retraction of each individual outrigger.
3. **Auto-Level Switch** - When this switch is in the “↕” extend position, each outrigger will extend and automatically adjust until the aerial platform is level. When the switch is in the “↕” retract position, the outriggers will retract.
4. **Outrigger Enable Switch** - This “Ⓜ” outrigger enable switch, when in the extend or retract position, activates the functions on the auto-level switch and the outrigger extend/retract switches.

5. **Leveling Indicator Light** - This light functions when the auto and manual level functions are in use and illuminates to display the status of the auto-leveling outriggers. The indicator light has the following states:

- ❗ **Off:** The outriggers are fully retracted.
- ❗ **Flashing Rapidly:** The outriggers are extending or retracting.
- ❗ **Flashing:** Not all outrigger legs have firm ground contact or aerial platform is not level.
- ❗ **On:** The outriggers are extended and the platform is level.

3.6-2 Powered Extension Control Console (If Equipped)

This control console is mounted on one of the extension platform guardrails. It contains the following controls:

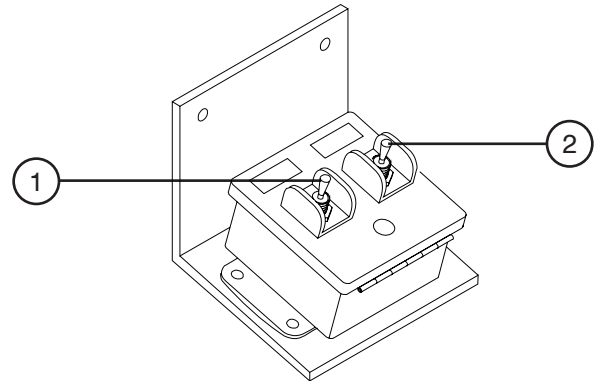

Figure 3-6. Powered Extension Control Console

1. **Enable Switch** - This switch, when activated and held, allows the extension platform extend/retract switch functions to operate.
2. **Extend/Retract Switch** - This switch, when activated, “↔” extends or “↔” retracts the powered extension platform. Refer to [Section 3.8-9](#) on how to extend/retract the powered extension platform.

3.6-3 1500W AC Inverter (If Equipped)

The inverter is located on the base of the aerial platform.
It has the following controls:

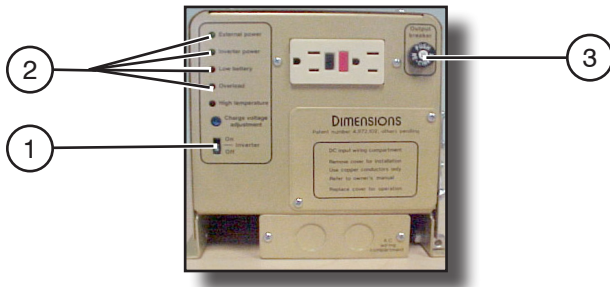

Figure 3-7. 1500W AC Inverter

NOTE

The inverter operation is automatic. These controls do not need to be manipulated for normal operation.

1. **On/Off Switch** - This diagnostic slide switch activates or terminates inverter operation. It should remain in the on position.
2. **Status LEDs** - These LEDs indicate the operating or fault status of the inverter.
3. **15 Amp Circuit Breaker** - In the event of a power overload or circuit grounding, the circuit breaker pops out. Press the breaker back in to reset.

3.7 Operator's Responsibility

It is the responsibility of the operator, prior to each work shift, to perform the following:

1. Visual and Daily Maintenance Inspections

- are designed to discover any damage of components before the aerial platform is put into service.
- are done before the operator performs the function tests.



WARNING

Failure to locate and repair damage, and discover loose or missing parts may result in an unsafe operating condition.

2. Function Tests

- are designed to discover any malfunctions before the aerial platform is put into service.

IMPORTANT

The operator must understand and follow the step-by-step instructions to test all aerial platform functions.

The operator should make a copy of the Operator's Checklist (see [Table 4.8](#)) and fill out the visual and daily maintenance inspections and the function tests sections while performing the items outlined in [Section 2.3](#) and [Section 2.4](#).

IMPORTANT

If damaged or any unauthorized variation from factory-delivered condition is discovered, the aerial platform must be tagged and removed from service.

Repairs to the aerial platform may only be made by a qualified service technician. After repairs are completed, the operator must perform visual and daily maintenance inspections & function tests again.

Scheduled maintenance inspections shall only be performed by qualified service technician (see [Table 4.7](#)).

3.8 Start Operation

Carefully read and completely understand the Operating Manual and all warnings and instruction labels (refer to [Section 5- Labels](#)) on the aerial platform.



WARNING

Do not operate this aerial platform without proper authorization and training. Failure to avoid this hazard could result in death or serious injury.

Before operating this aerial platform, perform the following steps:

1. Visual and daily maintenance inspections (see [Section 2.3](#))
2. Function tests (see [Section 2.4](#))
3. Jobsite inspection
It is the responsibility of the operator to perform a jobsite inspection and avoid the following hazardous situations:
 - holes or drop-offs
 - ditches or soft fills
 - floor obstructions, bumps or debris
 - overhead obstructions
 - electrical cords, hoses and high voltage conductors
 - hazardous locations
 - inadequate surface support to withstand all load forces imposed by the aerial platform
 - wind and weather conditions
 - the presence of unauthorized personnel
 - other possible unsafe conditions



WARNING

An operator should not use any aerial platform that:

- **does not appear to be working properly.**
- **has been damaged or appears to have worn or missing parts.**
- **has alterations or modifications not approved by the manufacturer.**
- **has safety devices which have been altered or disabled.**
- **has been tagged or locked out for non-use or repair.**



Failure to avoid these hazards could result in death or serious injury.

3.8-1 To Activate Base Control Console



WARNING

Ensure that you maintain three points of contact when using the ladder to mount/dismount platform.

1. Use the ladder of aerial platform to access platform.
2. Close the gate.
3. On platform control console, push in “” emergency stop button.
4. Insert key into off/lift/drive key switch and select “” lift position.
5. Select low/high throttle switch to “” low throttle position.



CAUTION



Do not start the engine in the high throttle position.

6. Use the ladder to dismount from platform.
7. Turn main power disconnect switch to “|” on position.
8. On base control console, pull out “” emergency stop button. A beeping sound should be audible and light should come on.



WARNING

If beeping sound is not audible and light does not come on, aerial platform must be tagged and placed out of service.

9. On engine control console, select off/on/start switch to “|” on position.
10. If diesel engine is cold, select and hold “” glow plug switch for 15 to 20 seconds or until indicator light goes off.
11. Depress and hold “” engine start pushbutton to start the engine.

3.8-2 To Raise or Lower Platform Using Base Control Console





WARNING

Be aware of overhead obstructions or other possible hazards around the aerial platform when lifting.



WARNING

Do not lower the platform unless the area below is clear of personnel and obstructions.

1. Activate base control console (refer to Section 3.8-1).
2. Select and hold enable switch.
3. Select and hold lower/neutral/raise switch to either  "raise" or  "lower" position. Release switch to stop.



3.8-3 To Activate Platform Control Console

1. Turn main power disconnect switch to "I" on position.
2. On engine control console, select off/on/start switch to "I" on position.
3. On base control console, pull out  emergency stop button.



WARNING

Ensure that you maintain three points of contact when using the ladder to mount/dismount platform.

4. Use the ladder of aerial platform to access platform.
5. Close the gate.
6. On platform control console, insert key into off/lift/drive key switch and select  "lift" position.
7. Pull out  emergency stop button. A beeping sound should be audible and light should come on.



WARNING

If beeping sound is not audible and light does not come on, aerial platform must be tagged and placed out of service.

8. Select low/high throttle switch to  low throttle position.



CAUTION

Do not start the engine in the high throttle position.

9. If diesel engine is cold, depress and hold glow plug pushbutton for 15 to 20 seconds.
10. Depress and hold  engine start pushbutton to start the engine.

3.8-4 To Raise or Lower Platform Using Platform Control Console





WARNING

Be aware of overhead obstructions or other possible hazards around the aerial platform when lifting.



WARNING

Do not lower the platform unless the area below is clear of personnel and obstructions.

1. Activate platform control console (refer to [Section 3.8-3](#)).
2. Press and hold lift “” enable pushbutton, then select and hold raise/off/lower switch to either “” raise or “” lower position. Release switch to stop.



WARNING

To protect against unintended movement of the aerial platform, push in the emergency stop button after you have arrived at your desired location or elevation.

NOTE

If the tilt alarm sounds and the platform does not, or only partially raises, immediately lower the platform completely and ensure that the aerial platform is on a firm level surface.

NOTE

Some models may be equipped with an 8-meter lift height restriction. To raise the platform higher than 8 meters, the aerial platform's outriggers must be properly deployed before lifting from a fully lowered position. Refer to [Section 3.8-10](#).

3.8-5 To Drive Forward or Backward





WARNING

Be aware of blind spots when operating the aerial platform.



WARNING

Ensure that there are no personnel or obstructions in the path of travel, including blind spots.



1. Activate platform control console (refer to [Section 3.8-3](#)).
2. On platform control console, select off/lift/drive key switch to “” drive position.
3. Activate and hold “” enable trigger switch.
4. Push or pull controller handle forward or backward to desired speed and direction of platform travel.
5. Return controller to neutral center position to stop. Release “” enable trigger switch.



WARNING

To protect against unintended movement of the aerial platform, push in the emergency stop button after you have arrived at your desired location or elevation.

3.8-6 To Steer

1. Activate platform control console (refer to [Section 3.8-3](#)).
2. Select off/lift/drive key switch to  drive position.
3. Activate and hold  enable trigger switch.
4. Press  rocker on top of controller handle in either direction to steer.

NOTE

Steering is not proportional. Driving and steering can be activated at the same time.

3.8-7 To Select Drive Torque

1. **High Torque:** Select high torque when ascending or descending grades, traveling on rough terrain or when loading or unloading aerial platform. To activate high torque, select low/high speed range switch to  low speed (high torque) position.

**WARNING**

Aerial platform must be in fully retracted position when operated on any grade. Driving while elevated on any grade may result in death or serious injury.

2. **Low Torque:** Select low torque when traveling on a flat level surface. To activate low torque, select low/high speed range switch to  high speed (low torque) position.

**WARNING**

To protect against unintended movement of the aerial platform, push in the emergency stop button after you have arrived at your desired location or elevation.

3.8-8 To Extend or Retract Manual Extension Platform

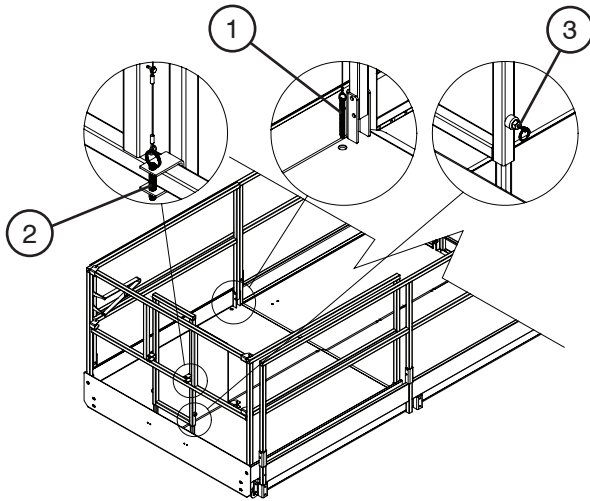







Figure 3-8. Manual Extension Platform

1. To extend/retract the manual extension platform, remove the locking pin (item 1) then remove the push bar locking pins (item 2) and rotate the push bar towards the main platform. Extend the push bar until it locks at full extension and push/pull the extension platform using the push bar.
2. Upon full extension or retraction, reinsert the locking pin on the platform (item 1) to prevent accidental movement of the manual extension platform during travel or transport.
3. When the push bar is not in use, pull the plungers (item 3) on the push bar and retract it, then rotate it back to its resting position and lock it into place with the locking pins (item 2).

3.8-9 To Extend or Retract Powered Extension Platform (If Equipped)

1. To extend the powered extension platform, ensure “” emergency stop button is pulled out.
2. On platform control console, insert key into off/lift/drive key switch and select “” lift position.
3. On the powered extension control console, select and hold “” enable switch, then push the extend/retract switch to the “” extend position. Release switch to stop.
4. To retract platform, select and hold “” enable switch, then push extend/retract switch to “” retract position. Release switch to stop.



WARNING

To protect against unintended movement of the aerial platform, push in the emergency stop button after you have arrived at your desired location or elevation.



3.8-10 Hydraulic Outriggers (If Equipped)

These devices are mounted to the four corners of the base.

3.8-10a Before Operation





1. Move around aerial platform to check overhead clearances and ground obstructions.
2. Lower the platform completely. Refer to [Section 3.8-4](#). Outrigger controls are not functional when platform is raised.
3. Check that the supporting surface under the tires and outrigger pads is firm and capable of supporting aerial platform and rated load. Do not place outrigger pad on a street drain, manhole cover or other unsupported surface.

3.8-10b To Extend Outriggers

1. On outrigger control console, select and hold “” enable switch to provide power to outrigger circuit.
2. **Auto Extension:** Select auto-level switch to “” extend position until leveling indicator light stops flashing and remains on. Aerial platform should be level and completely supported by the outriggers.

Manual Extension: Select corresponding outrigger extend/retract switch to “” extend position until platform is fully supported by outriggers and is level. The indicator light flashes while platform is being leveled and remains on once platform is level.

The indicator light has the following states:

-  **Off:** The outriggers are fully retracted.
-  **Flashing Rapidly:** The outriggers are extending or retracting.
-  **Flashing:** Not all outrigger legs have firm ground contact or aerial platform is not level.
-  **On:** The outriggers are extended and the platform is level.

3. Ensure each outrigger pad is in firm contact over its entire surface area, with a suitable supporting surface! Make adjustments if necessary using manual outrigger controls.
4. Operate all non drive functions as described in their respective sections.

NOTE

Each outrigger pad must be in firm contact with the ground for most aerial platform functions to work.



NOTE

Drive functions are disabled if the outriggers are in any position other than fully retracted.

**WARNING**

If alarm sounds during operation, the aerial platform is not level or an outrigger does not have firm ground contact. Lower the platform immediately! Make the necessary adjustments to level the aerial platform.

3.8-10c To Retract Outriggers



1. Ensure platform is fully lowered.
2. On outrigger control console, select and hold “” enable switch to provide power to outrigger circuit.
3. **Auto Retraction:** Select auto-level switch to “” retract position until outriggers are fully retracted.

Manual Retraction: Select corresponding pairs of outrigger extend/retract switch to “” retract position until outriggers are fully retracted.

NOTE

Limit switches are used to protect outriggers from being damaged. If drive functions are not available, visually check to see that all outriggers are fully retracted.

3.8-11 Generator (If Equipped)**To start the hydraulic generator:**

1. On platform control console, select off/lift/drive key switch to  lift position.
2. Depress and hold  engine start pushbutton to start the engine.
3. On auxiliary control console, select hydraulic generator switch to “I” energized position. Engine will automatically switch to high throttle and generator will start.

To stop the hydraulic generator:

1. Select hydraulic generator switch to “O” off position. The generator will turn off and throttle will return to selected speed.

NOTE

Activating any lift or outrigger functions, changing the key switch setting, activating the emergency stop or an engine stall will turn off the generator. The platform may be lowered during generator operation.

3.8-12 Electrical Inverter (If Equipped)

The inverter is operational with alternating current available at all times when, and only when, the engine is running at high throttle. Deselecting the high idle throttle setting or stopping the engine will turn the inverter off.

To check the status of the inverter:

1. During routine operation, the on/off switch should remain in the on position. To prevent automatic inverter operation when high throttle is activated, slide the on/off switch on the inverter to the off position.
2. Inverter state is indicated by the LEDs on the face of the inverter. A glowing green LED indicates normal operation. If a fault occurs, the status LEDs will indicate the area responsible. After the fault condition is corrected, the inverter will automatically reset itself.

3.8-13 Shutdown Procedure

1. Completely lower the platform.
2. On platform control console, push in  emergency stop button.
3. Select off/lift/drive key switch to “O” off position and remove key.

**WARNING**

Ensure that you maintain three points of contact when using the ladder to mount/dismount the platform.

4. Use the ladder to dismount from platform.
5. On base control console, push in  emergency stop button.
6. On engine control console, select engine off/on/start switch to “O” off position.
7. Turn main power disconnect switch to “O” off position.

3.9 Refueling Procedure

This section provides the operator with the procedure on how to refuel the engine with regular fuel and install the propane cylinder.

IMPORTANT

Before using the aerial platform ensure there is enough fuel to finish the job.



WARNING

Failure to heed the following safety precautions could result in death or serious injury:

- **Use extreme caution while refueling aerial platforms.**
- **Ensure engine and all systems are turned off before refueling.**
- **Refuel aerial platform only in a well ventilated area away from open flame and other sources of ignition, authorized by your employer and supervisor.**
- **To minimize possible static electricity fires, ensure filler nozzle touches rim of filler opening to aid the dissipation of static electricity.**
- **Never try to start an aerial platform if you smell gas.**



WARNING

Do not smoke in an area where aerial platforms are stored or refueled.

3.9-1 Regular Fuel (Diesel)

1. Ensure engine and all systems are turned off and emergency stop buttons are depressed.
2. Open fuel compartment door and remove fuel cap.
3. Carefully fill the fuel tank ensuring that no spillage occurs.
4. Securely replace fuel cap.
5. Ensure there are no leaks in the fuel system.
6. Wipe up any spilled fuel.
7. Dispose of rags in an approved container.

Protection of Environment from Chemical Dangers



WARNING

Gasoline, diesel fuel, engine oil and hydraulic fluid are chemicals, which can contaminate the environment. If they are spilled during filling and reach the water, they can cause damage to the environment, e.g., death of fish. For such damage, the party responsible is liable! Therefore, gasoline, diesel fuel, engine oil or hydraulic fluid must not get into the sewage system, streams, rivers or other surface water. For that reason, immediately remove the dripped off or spilled gasoline, diesel fuel, engine oil or hydraulic fluid with appropriate means and dispose of these means according to the regulations.

3.10 Loading/Unloading

Know and heed all national, state or territorial/provincial and local rules which apply to your loading/unloading of aerial platforms.

Only qualified personnel shall operate machinery during loading/unloading.

Be sure vehicle capacity and loading equipment hoists, chains, straps, etc., are sufficient to withstand maximum aerial platform weight.

The transport vehicle must be parked on a level surface and must be secured to prevent rolling while aerial platform is being loaded/unloaded.

3.10-1 Lifting



WARNING

Only qualified rigger shall perform lifting.

When it is necessary to lift the aerial platform the following conditions must be met:

- The platform must be fully lowered.
- The main power disconnect switch must be in “○” off position.
- The hydraulic/electrical and fuel compartments must be closed and securely latched.
- The extension platform must be retracted and secured.
- The platform control console must be secured to the railings or removed.
- The platform must be cleared of all personnel, tools and materials.
- The lifting/rigging may be attached to all four lifting points as illustrated in [Figure 3-9](#).

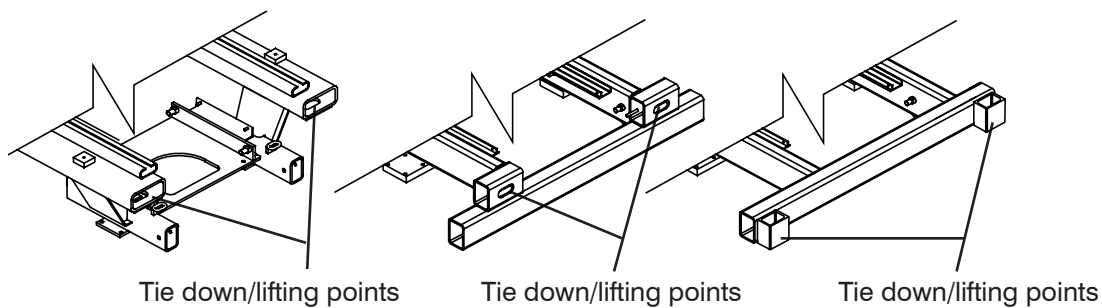

Figure 3-9. Tie Downs/Lifting Points

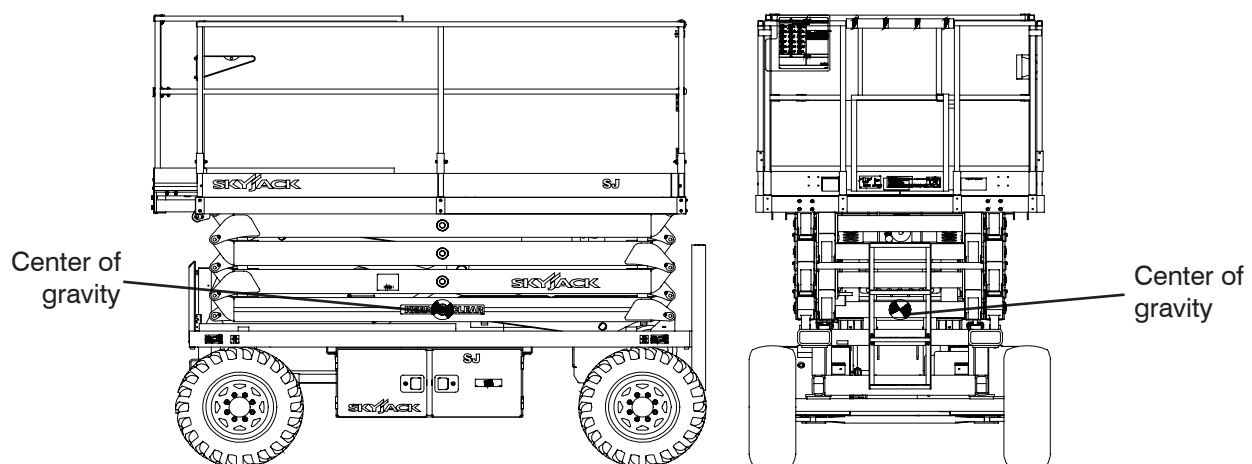

Figure 3-10. Center of Gravity

NOTE

The mass of the aerial platform is as per [Table 4.3](#). The center of gravity is approximately located in the middle of the aerial platform, front to back and side to side, as illustrated in [Figure 3-10](#). Vertically, the center of gravity is approximately just above the base chassis.

NOTE

Except for Models 92xx, the aerial platform can be lifted with a forklift from the sides, but Skyjack does not recommend this use. Lift with forks in designated pockets as illustrated in [Figure 3-11](#).

3.10-2 Driving

Before driving the aerial platform:

- Ramp or dock capacity must be sufficient to withstand maximum aerial platform weight.
- Ramp should be equipped with side guards to prevent inadvertent fall from the ramp.
- Incline must not exceed aerial platform gradeability (refer to [Table 4.3](#)).
- Aerial platform brake must be checked for proper operation.
- Aerial platform speed must be on high torque setting.

**WARNING**

When transporting, the aerial platform must be secured to the truck or trailer deck. Tie downs are available as illustrated in [Figure 3.9](#).

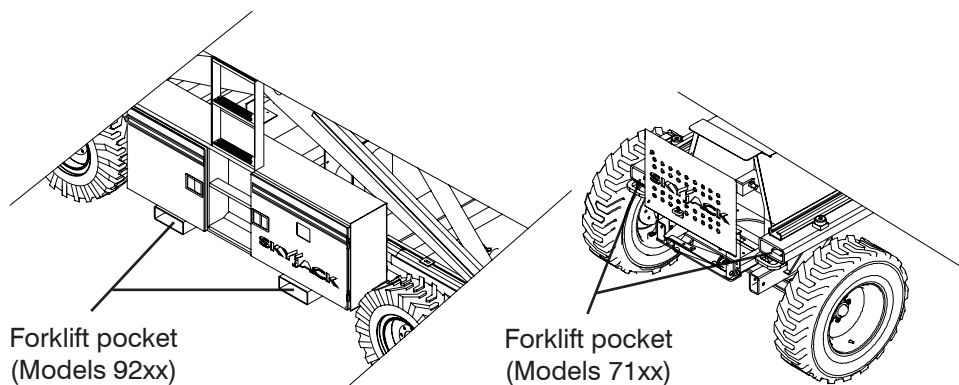

Figure 3-11. Forklift Pockets

3.11 Guardrail Folding Procedure

When folded down, the folding guardrail system reduces the overall height of the retracted aerial platform for transporting only.



WARNING

Any lowered guardrail will create a fall hazard. To avoid falling, remain away from the sides of the platform while raising or lowering the guardrails.

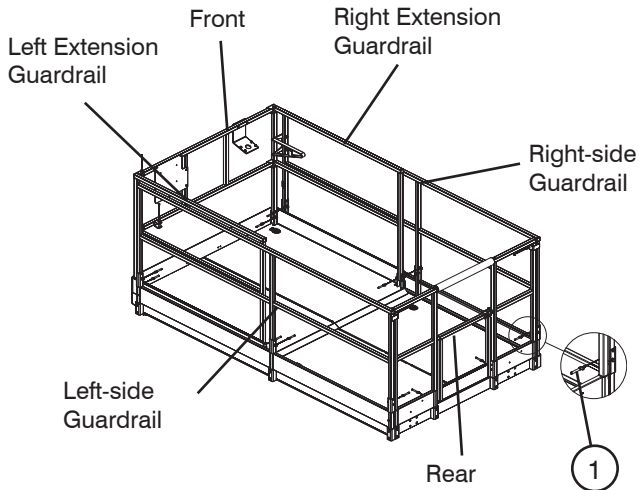

Figure 3-12. Folding Guardrail System

1. **Guardrail Locking Pin with Lanyard** - This pin is used to lock the guardrail in place.



WARNING

Before operating this aerial platform check the guardrail system for loose or missing locking pins. The guardrail system must be upright and all pins must be locked in place. Death or serious injury could result if the guardrail system is not upright or properly locked.



WARNING

The scissor assembly must be fully lowered before raising or lowering the guardrails.

To fold the guardrail system down:

1. Ensure aerial platform is on level ground and all extension platforms are fully retracted.
2. Turn main power disconnect switch to “○” off position.



WARNING

Ensure that you maintain three points of contact when using the ladder to mount/dismount platform.

3. Use the ladder of aerial platform to access platform.
4. Close the gate.



WARNING

Any lowered guardrail will create a fall hazard. Remain away from the sides of the platform while raising or lowering the guardrails to avoid falling.

5. Remove the platform control console and outrigger control console (if equipped) and lay it down on the platform.
6. Fold guardrails down in the following order: rear, front, left extension, right extension, left-side and right-side (refer to [Figure 3-12](#)).
7. Remove all the locking pins on the rear guardrail and fold the guardrail down.
8. If there is a manual extension, remove all locking pins on the push bar and fold it down.
9. Remove all the locking pins that secured the front guardrail to the left extension guardrail then swing it towards the right extension and lock it in place.
10. Remove all the locking pins on the left extension and fold it down.
11. Remove all the locking pins on the right extension guardrail and fold it down.
12. Remove all the locking pins on the left-side guardrail and fold it down.

- Remove all the locking pins on the right-side guardrail and fold it down.

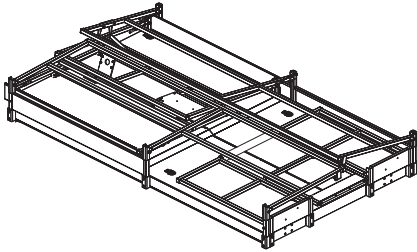

Figure 3-13. All Guardrails Folded Down

To raise the guardrail system up:



WARNING

The scissor assembly must be fully lowered before raising or lowering the guardrails.

- Ensure aerial platform is on level ground.
- Turn main power disconnect switch to “○” off position.



WARNING

Ensure that you maintain three points of contact when using the ladder to mount/dismount platform.

- Use the ladder of aerial platform to access platform.



WARNING

Any lowered guardrail will create a fall hazard. Remain away from the sides of the platform while raising or lowering the guardrails to avoid falling.



WARNING

Ensure that the detent ball of each locking pin is all the way through and each spring clip is fully inserted into the pin hole.

- Raise the guardrails up in the following order: right-side, left-side, right extension, left extension, front and rear.
- Swing the right-side guardrail up and lock it in place by inserting all locking pins.

- Swing the left-side guardrail up and lock it in place by inserting all locking pins.
- Swing the right extension guardrail up and lock it in place by inserting all locking pins on the right extension.
- Swing the left extension guardrail up and lock it in place by inserting all locking pins.
- Remove the locking pins and swing the front guardrail forward. Lock it in place by inserting all locking pins.
- If there is a manual extension, swing push bar up and lock in place by inserting all locking pins.
- Swing the rear guardrail up then lock it in place by inserting all locking pins.
- Mount the platform control console and outrigger control console (if equipped) at the front right of the platform. Lock them in place.



WARNING

Before operating this aerial platform check the guardrail system for loose or missing locking pins. The guardrail system must be upright and all pins must be locked in place. Death or serious injury could result if the guardrail system is not upright or properly locked.

3.12 Maintenance Support Procedure

This section provides the operator with procedure regarding deployment and storage of maintenance support.

The maintenance support is a safety mechanism designed to support the scissor assembly. When properly positioned it can support the scissor assembly and empty platform. The maintenance support must be used when inspection and/or maintenance is to be performed within the lifting mechanism.



WARNING

The maintenance support must be used when inspection and/or maintenance or repairs are to be performed within the lifting mechanism. Failure to use this safety mechanism could result in death or serious injury.

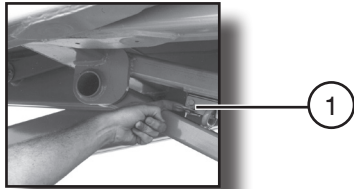

Figure 3-14. Maintenance Support

To Deploy the Maintenance Support

1. Remove all material from platform.
2. Raise platform until there is adequate clearance to swing down maintenance support (item 1).
3. Push latch lever rearward.
4. Swing maintenance support down from storage bracket into a vertical position.
5. Remove hands and arms from scissors area.
6. Lower platform until bottom end of maintenance support contacts the labeled cross bar and scissors are supported by maintenance support.
7. Turn main power disconnect switch to "○" off position.

To Store the Maintenance Support

1. Turn main power disconnect switch to "I" on position.
2. Raise platform until there is adequate clearance to swing up the maintenance support.
3. Swing bar fully up into storage latch.
4. Lower the platform.



WARNING





Do not reach through the scissor assembly when the platform is raised without the maintenance support properly positioned. Failure to avoid this hazard could result in death or serious injury.

Table 4.1 Standard and Optional Features

Models	Mid-Size Rough Terrain		Full-Size Rough Terrain		
	7127	7135	8831	8841	9250
STANDARD EQUIPMENT					
21.6 kW (29 hp) Kubota D1305 diesel water-cooled engine	*	*	*	*	*
4WD	*	*	*	*	*
Access ladders and half-height spring-hinged gates at both sides of platform			*	*	*
Base control console	*	*	*	*	*
Color coded and numbered wiring system	*	*	*	*	*
Diamond pattern, all steel platform deck construction	*	*	*	*	*
Disc brake system on rear axle	*	*	*	*	*
D-rings (lanyard attachment points)	*	*	*	*	*
Flashing light and descent alarm	*	*	*	*	*
Forklift pockets	*	*			*
Front and rear mounted 1.2 m rollout extension platform			*	*	
Front mounted 1.4 m roll out extension platform	*	*			
Front and rear mounted 1.5 m powered extension platform					*
Hinged railing system with 15.25 cm (6 in.) toe boards	*	*	*	*	*
Hourmeter	*	*	*	*	*
Hydraulic oil level and temp. indicators	*	*	*	*	*
Lockable cabinets with swing-out door	*	*	*	*	*
Lowering warning system	*	*	*	*	*
Manual brake release	*	*	*	*	*
Maximum drive height	Full Height	Full Height	Full Height	Full Height	7.9 m
Operator horn	*	*	*	*	*
Overload sensing system	*	*	*	*	*
Platform control console	*	*	*	*	*
Rollout engine tray	*	*	*	*	*
Scissor guards	*	*	*	*	*
Self-centering scissors design			*	*	*
Tie downs/lifting eyes	*	*	*	*	*
Tie-down points	*	*	*	*	*
Tilt alarm with drive/lift cut out	*	*	*	*	*
Type #6 Foam-filled tires	*	*	*	*	*
Wiring for AC outlet on platform	*	*	*	*	*
OPTIONAL EQUIPMENT					
3500 watt hydraulic generator	*	*	*	*	*
All motion audible alarm	*	*	*	*	*
Comprehensive parts/operating and service manual	*	*	*	*	*
Front and rear mounted 1.2 m powered extension platform	*	*	*	*	
Front mounted 1.4 m powered extension platform	*	*			
Full-height spring-hinged gates at both sides of platform			*	*	
Grip lug, foam filled non marking tires	*	*	*	*	*
Hinged railing system					
Independent/auto leveling outriggers	*	*	STD	STD	STD
Rotating amber beacon	*	*	*	*	*
Shop air line to platform	*	*	*	*	*

139AA-AS

Table 4.2 Owner's Annual Inspection Record

										
 Model Number: _____ Serial Number: _____										
*			20__	20__	20__	20__	20__	20__	20__	20__
**										

1000AA

As described earlier in this section, this decal is located on the scissor assembly. It must be completed after an annual inspection has been completed. Do not use the aerial platform if an inspection has not been recorded in the last 13 months.



	Pictorial	Description
*		Inspection Date
**		Inspector Signature

Table 4.3 Specifications and Features

MODEL	7127	7135	8831	8841	9250
Weight *	3972 kg	4259 kg	5684 kg	6173 kg	7407 kg
Overall width	1.81 m		2.2 m		2.34 m
Overall length	3.82 m		3.7 m		4.55 m
Platform Size (inside)	1.63 m x 2.97 m		1.7 m x 3.5 m		1.85 m x 4.39 m
Height					
Working Height	10.2 m	12.6 m	11.6 m	14.5 m	17.2 m
Platform Elevated Height	8.2 m	10.6 m	9.6 m	12.5 m	15.2 m
Stowed Platform Height	1.53 m	1.71 m	1.5 m	1.8 m	2 m
Drive Height	Full				7.9 m
Standard Operating Times					
Lift Time (Rated Load)	38 s	38 s	52 s	56 s	64 s
Lower Time (Rated Load)	47 s	45 s	47 s	53 s	86 s
Chassis					
Normal Drive Speed	5.69 km/h		4.2 km/h		3.8 km/h
Elevated Drive Speed	0.50 km/h		0.35 km/h		0.72 km/h
Gradeability (Ramp Angle)	30%				
Tires (Solid Rubber)	Refer to Table 4.6 for tire specification and usage.				
Hydraulic Oil					
Type	ATF Dexron III				
Tank Capacity (Liters)	80.48		75.71		67.38
Engine (RPM)					
Engine Type	Kubota D1305				
RPM Settings	1400 (Low) / 2800 (High)				
Fuel Type	Diesel				
Fuel Tank Capacity (Liters)	80.48		49.21		64.35
Engine Oil Type	SAE 10W-30				
Recommended Alternative Engine Oil	10W-30, API Service Designation CG-4, CF-4, CF, CD, SH				
Engine Oil Capacity (Liters)	6.0				
Coolant Type	Anti-freeze / Water				
Coolant Capacity (Liters)	4.0				
Sound Pressure Level (ISO 3744)	67dB(A)				
Guaranteed Maximum Sound Power Level (ISO 4871)	103dB				

140AA-AS

* Weights are approximate; refer to serial nameplate for specific weight. Values shown for models 7127 & 7135 are for standard 4WD aerial platforms on foam filled tires and a manual extension platform. Values shown for models 8831, 8841 are for standard 4WD aerial platforms on foam filled tires and two rollout extension platforms. Values shown for model 9250 are for standard 4WD on foam tires with two powered extension platforms.

Table 4.4 Maximum Platform Capacities (Evenly Distributed)

MODEL		Total		First Extension		Second Extension	
		Capacity	Number of Occupants	Capacity	Number of Occupants	Capacity	Number of Occupants
7127	One Extension Platform	680 kg	5	227 kg	2	Not Available	
7135	One Extension Platform	454 kg	4	159 kg	1	Not Available	
8831	Two Extension Platform	908 kg	6	227 kg	2	227 kg	2
8841	Two Extension Platform	681 kg	5	227 kg	2	227 kg	2
9250	Two Extension Platform	681 kg	5	227 kg	2	227 kg	2

141AA-AS

NOTE:

Occupants and materials are not to exceed rated load.

Capacities listed are for standard machines equipped with #6 tires.

Refer to capacity label at sides of platform for additional information and for models equipped with options.

Note: Maximum Wind Speed = 12.5 m/sec

Table 4.5 Floor Loading Pressure

MODEL		Total Aerial Platform Weight	Total Aerial Platform Load		
			WHEEL	LCP **	OUP **
		kg	kg	kPa	kg/m ²
7127	min*	3972	1589	1117	686
	max*	5155	2062	1240	890
7127 Outrigger Pads	min*	4388	1755	340	635
	max*	5155	2062	399	746
7135	min*	4259	1704	1151	735
	max*	5216	2086	1246	901
7135 Outrigger Pads	min*	4675	1870	362	676
	max*	5216	2086	404	754
8831	min*	5536	2214	1254	719
	max*	6788	2715	1399	882
8831 Outrigger Pads	min*	5831	2333	451	690
	max*	6788	2715	525	804
8841	min*	6174	2448	1312	795
	max*	7145	2858	1455	928
8841 Outrigger Pads	min*	6174	2566	496	759
	max*	7145	2858	553	846
9250	min*	7407	2963	1490	969
	max*	8137	3255	1576	975
9250 Outrigger Pads	min*	7407	2963	573	765
	max*	8137	3255	630	770

142AA-AS

* min - Total aerial platform weight with no options

max - Aerial platform weight + all options + capacity

** **LCP - Locally Concentrated Pressure** is a measure of how hard the aerial platform presses on the areas in direct contact with the floor. The floor covering (tile, carpet, etc.) must be able to withstand more than the indicated values above.

OUP - Overall Uniform Pressure is a measure of the average load the aerial platform imparts on the whole surface directly underneath it. The structure of the operating surface (beams, etc.) must be able to withstand more than the indicated values above.

NOTE:

The LCP or OUP that an individual surface can withstand varies from structure to structure and is generally determined by the engineer or architect for that particular structure.

Floor Loading Pressure

Locally Concentrated Pressure (LCP):

Foot Print Area = Length x Width

$$\text{or} = \frac{\pi D^2}{4} \text{ (for outriggers)}$$

$$\text{LCP} = 0.4 \times \frac{\text{Weight of Aerial Platform} + \text{Capacity}}{\text{Foot Print Area}}$$

Overall Uniform Pressure (OUP):

Base Area = Length x Width

$$\text{OUP} = \frac{\text{Weight of Aerial Platform} + \text{Capacity}^*}{\text{Base Area}}$$

* Capacity for max OUP only.

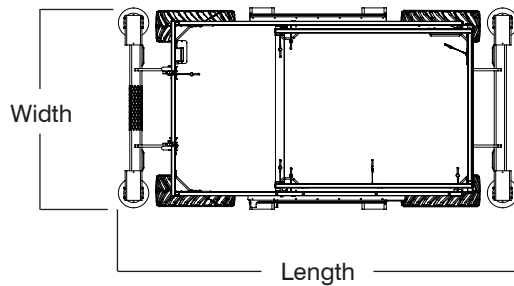
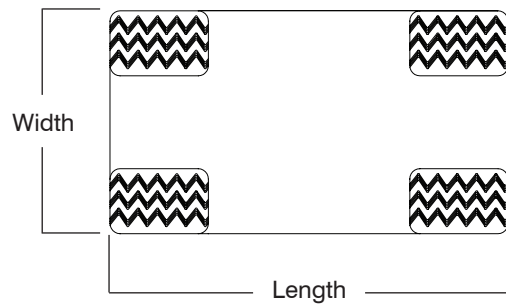
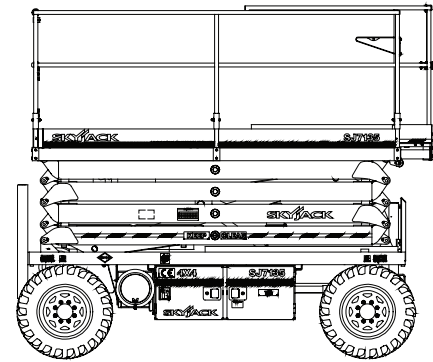
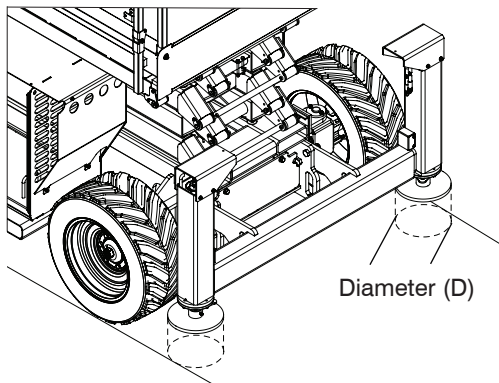
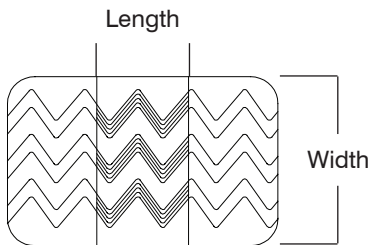
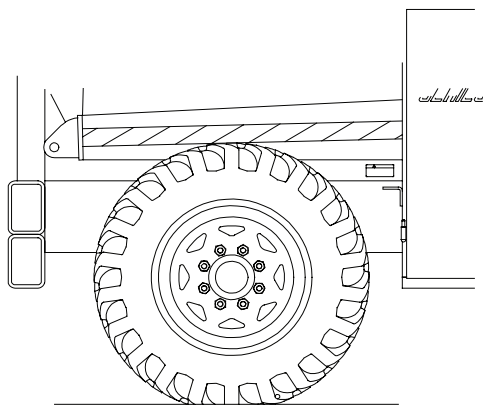

Table 4.6 Tire Specifications



WARNING

Tires must be checked by end user on a daily basis. Do not intermix tires of different types on one aerial platform. Use only tires of type originally supplied.

Tire Size	Fill Specification			Usage*				
	Fill Type	Ply Rating	Pressure (Factory) (kPa)	MID SIZE		FULL SIZE		
				7127	7135	8831	8841	9250
#6F 10-16.5 CARLISLE US LOADER	Foam	10	N/A	S	S	S	S	S
#6F 10-16.5 OTR OUTRIGGER (Non-Marking)		10	N/A	O	O	O	O	N/A

143AA-AS

* Usage: (S)tandard Or (O)ptional
(N/A) Not Available

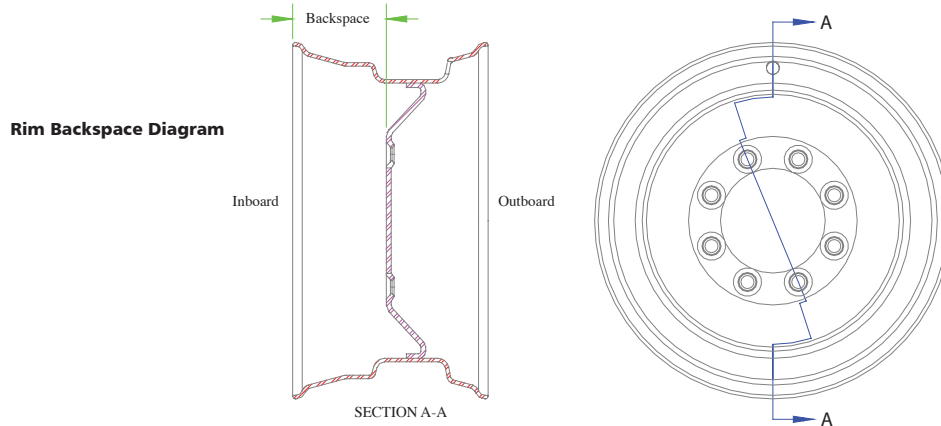

Rim Size	Backspace				
	7127	7135	8831	8841	9250
#6F	95 mm	95 mm	121 mm	121 mm	95 mm

144AA-AS



WARNING

Intermixing tires of different types or using tires of types other than those originally supplied with this equipment can adversely affect stability. Therefore, replace tires only with the exact original Skyjack-approved type. Failure to operate with matched approved tires in good condition may result in death or serious injury.

General Maintenance

Before attempting any repair work, disconnect battery by turning main power disconnect switch to “○” off position. Preventive maintenance is the easiest and least expensive type of maintenance.

Table 4.7 Maintenance and Inspection Schedule

Frequency	Daily	3 months or 150 hours	Yearly	Frequency	Daily	3 months or 150 hours	Yearly
Visual and Daily Maintenance Inspections				Lifting Mechanism			
Labels	A			Scissor Guards	A		
Electrical	A			Sliders	A		
Limit Switches	A			Maintenance Support	A		
Hydraulic	A			Scissor Assembly	A		
Emergency Lowering Access Rod (All models except 9250)	A			Scissor Bumpers	A		
Hydraulic/Electrical Compartment				Lift Cylinder(s)	A		
Main Power Disconnect Switch	A			Base			
Base Control Switches	A			Base Weldment	A		
Battery	A			Wheel/Tire Assembly	A		
Manifolds	A			Drive Axle	A		
Electrical Panel	A			Steer Cylinder Assembly	A		
Load/Tilt Sensor	A			Tie Rod	A		
Hydraulic Tank (Model 9250)	A			Ladder	A		
Hydraulic Oil	A			Outriggers (If Equipped)	A		
Hydraulic/Fuel Compartment				Manuals			
Hydraulic Tank (Models 71xx & 88xx)	A			Function Tests			
Hydraulic Oil (Models 71xx & 88xx)	A			Platform Control Console			
Fuel Tank	A			Test Emergency Stop	A		
Fuel Leaks	A			Test Lift Enable	A		
Engine Compartment				Test Platform Raising/Lowering	A		
Engine Control Console	A			Test Enable Trigger Switch	A		
Radiator	A			Test Steering	A		
Muffler and Exhaust	A			Test Horn	A		
Engine Tray	A			Test Driving	A		
Hydraulic Pump	A			Test Brake	A		
Engine Oil Level	A			Test Speed Limit	A		
Engine Air Filter	A			Test Lowering Warning	A		
Fuel Leaks	A			Test Powerdeck Enable (If Equipped)	A		
Platform Assembly				Test Extension Platform(s) (If Equipped)	A		
Lanyard Attachment Anchors	A			Test Emergency Powered Extension Platform Retraction Switch (Model 9250)	A		
AC Outlet on Platform	A			Base Control Console			
Platform Control Console	A			Test Emergency Stop	A		
Powered Extension Control Console (If Equipped)	A			Test Base Lift Enable	A		
				Test Lower/Neutral/Raise Switch	A		
				Test Emergency Lowering (Models 71xx & 88xx)	A		
				Test Emergency Lowering (Model 9250)	A		
				Test Main Power Disconnect Switch	A		

B*†

B*†

B*†

60603AE-AS-R

A - Perform Visual and Daily Maintenance Inspections & Functions Test. Refer to Section 2.3 and Section 2.4 of this manual.

B - Perform Scheduled Maintenance Inspection. Refer to Service & Maintenance manual.

* - Maintenance must be performed only by trained and competent personnel who are familiar with mechanical procedures.

† - Refer to Skyjack's website @ www.skyjack.com for latest service bulletins prior to performing quarterly or yearly inspection.



WARNING

Use original or manufacturer-approved parts and components for aerial platform.

Table 4.8 Operator's Checklist



Serial Number: _____

Model: _____

Hourmeter Reading: _____

Date: _____

Time: _____

Operator's Name (Printed): _____

Operator's Signature: _____

Each item shall be inspected using the appropriate section of the Skyjack operating manual.
As each item is inspected, check the appropriate box.

- P** - PASS
- F** - FAIL
- R** - REPAIRED
- NA** - NOT APPLICABLE

INSPECTION FREQUENCY

- FREQUENTLY
- DAILY
- ANNUALLY
- BI-ANNUALLY

	N/A	P	F	R
Visual and Daily Maintenance Inspections				
Labels				
Electrical				
Limit Switches				
Hydraulic				
Emergency Lowering Access Rod (All Models Except 9250)				
Hydraulic/Electrical Compartment				
Main Power Disconnect Switch				
Base Control Switches				
Battery				
Manifolds				
Electrical Panel				
Load/Tilt Sensor				
Hydraulic Tank (Model 9250)				
Hydraulic Oil				
Hydraulic/Fuel Compartment				
Hydraulic Tank (Models 71xx & 88xx)				
Hydraulic Oil (Models 71xx & 88xx)				
Fuel Tank				
Fuel Leaks				
Engine Compartment				
Engine Control Console				
Radiator				
Muffler and Exhaust				
Engine Tray				
Hydraulic Pump				
Engine Oil Level				
Engine Air Filter				
Fuel Leaks				
Platform Assembly				
Lanyard Attachment Anchors				
AC Outlet on Platform				
Platform Control Console				
Powered Extension Control Console (If Equipped)				





	N/A	P	F	R
Lifting Mechanism				
Scissor Guards				
Sliders				
Maintenance Support				
Scissor Assembly				
Scissor Bumpers				
Lift Cylinder(s)				
Base				
Base Weldment				
Wheel/Tire Assembly				
Drive Axle				
Steer Cylinder Assembly				
Tie Rod				
Ladder				
Outriggers (If Equipped)				
Manuals				
Function Tests				
Platform Control Console				
Test Emergency Stop				
Test Lift Enable				
Test Platform Raising/Lowering				
Test Enable Trigger Switch				
Test Steering				
Test Horn				
Test Driving				
Test Brake				
Test Speed Limit				
Test Lowering Warning				
Test Powerdeck Enable (If Equipped)				
Test Extension Platform(s) (If Equipped)				
Test Emergency Powered Extension Platform Retraction Switch (Model 9250)				
Base Control Console				
Test Emergency Stop				
Test Base Lift Enable				
Test Lower/Neutral/Raise Switch				
Test Emergency Lowering (Models 71xx & 88xx)				
Test Emergency Lowering (Model 9250)				
Test Main Power Disconnect Switch				

Note:

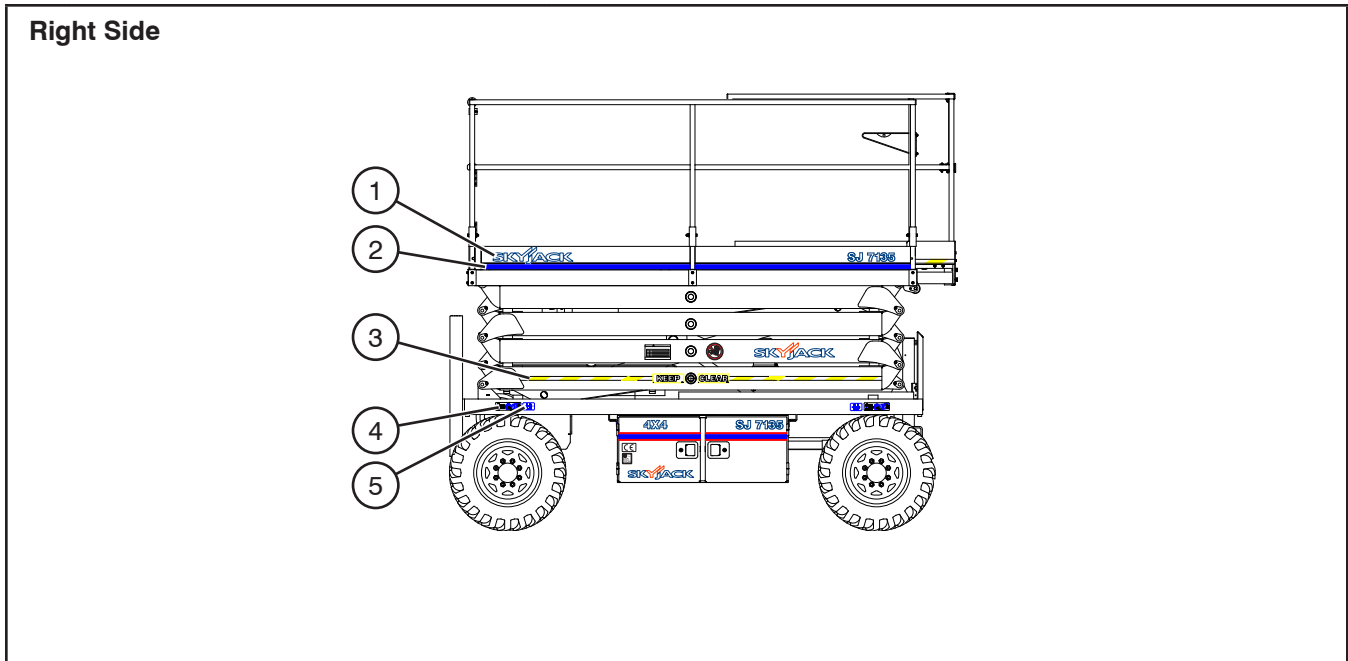

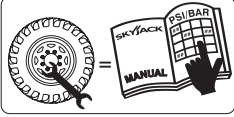

Make a copy of this page or visit the Skyjack web site:
www.skviack.com for a printable conv.

60604AD-AS-R

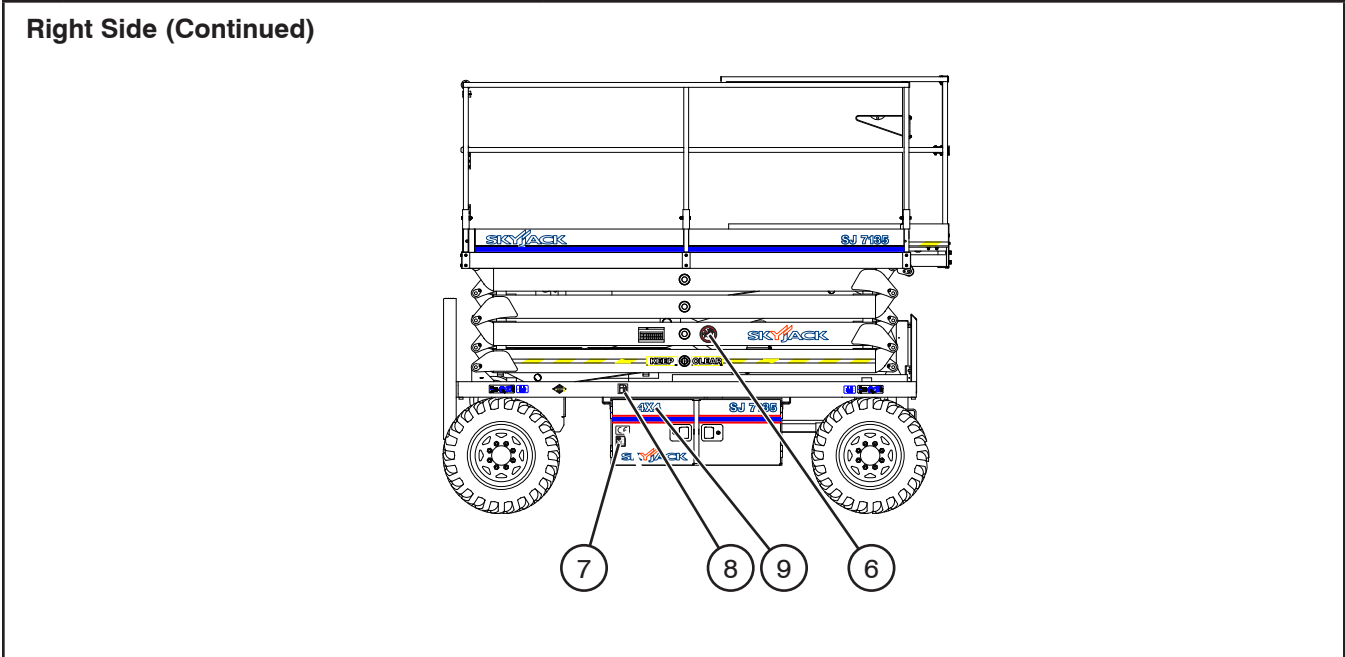



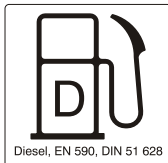

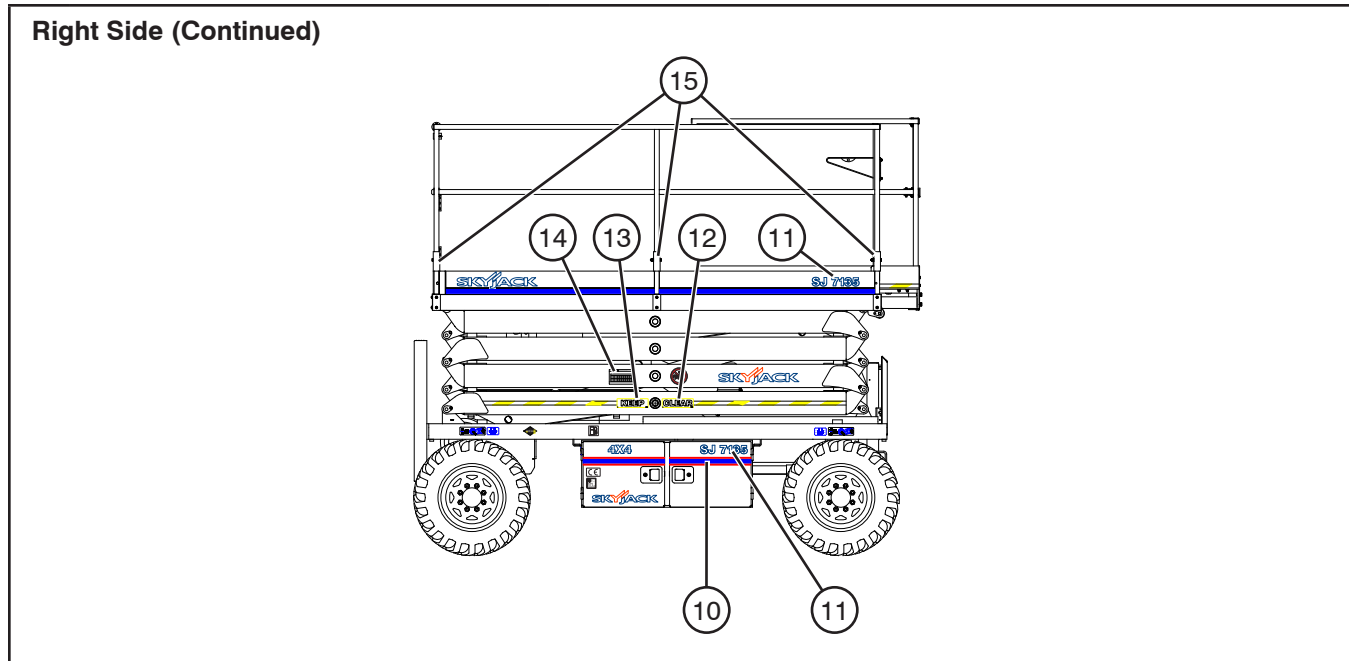

No.	Label Pictorial	Description
1		<p>Skyjack Logo Large Skyjack logo - blue and red</p>
2		<p>Tape Blue/White Skyjack pinstripe</p>
3		<p>Caution Tape Stripe Caution stripe</p>
4		<p>Wheel Specifications Refer to manual for wheel type, offset, pressure and torque.</p>
5		<p>Foam-filled & Wheel load* Indicate foam-filled tire and rated wheel load. *Wheel load will vary over different aerial platforms.</p>



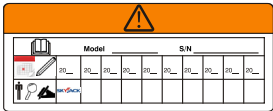

No.	Label Pictorial	Description
6		<p>“Keep Clear” Keep clear.</p>
7		<p>Sound Power Level Guaranteed maximum sound power level</p>
8		<p>Diesel Use diesel fuel only.</p>
9		<p>4x4 Product identifier - 4 wheel drive</p>



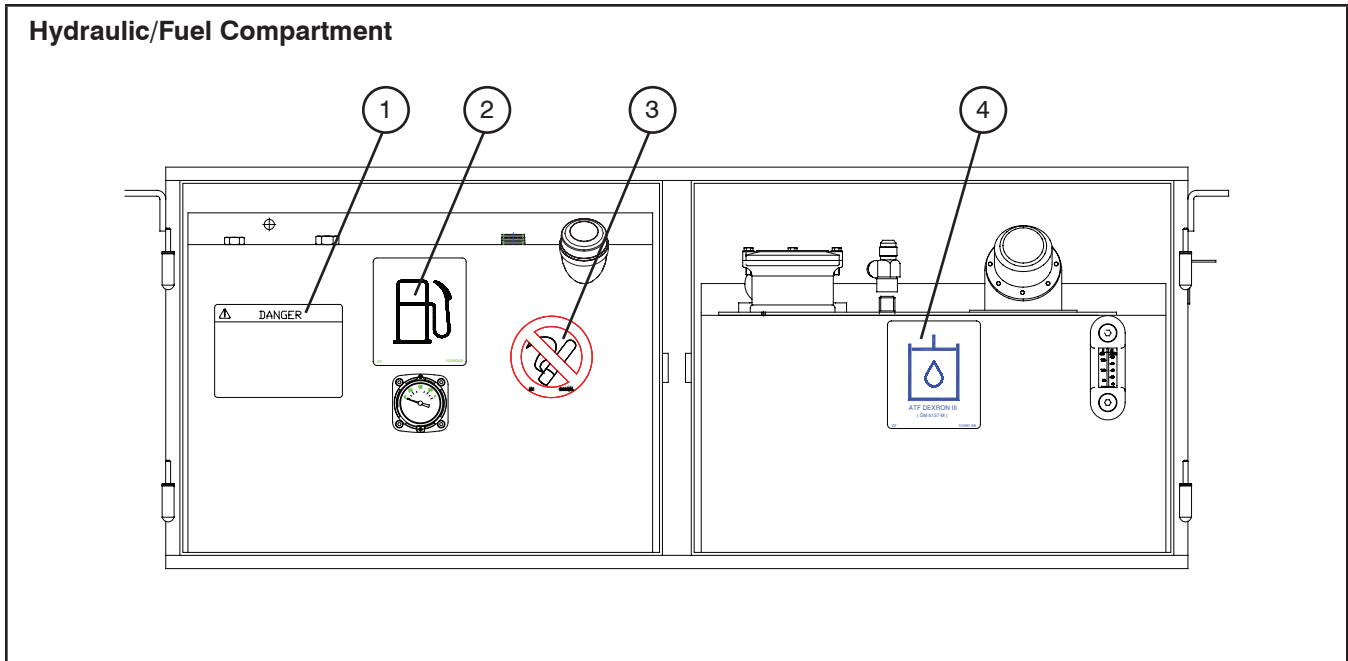

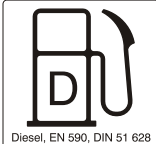

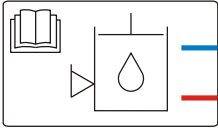
No.	Label Pictorial	Description
10		<p>Tape - Red/Blue/Red</p> <p>Skyjack pinstripe</p>
11		<p>Model Number*</p> <p>Product Identifier *Model number will vary, may not be as shown.</p>
12		<p>“Clear”</p> <p>Keep clear.</p>
13		<p>“Keep”</p> <p>Keep clear.</p>
14		<p>Annual Inspection</p> <p>Ensure that aerial platform has received annual inspection prior to operation.</p>
15		<p>Warning - Falling hazard. Hinge point.</p> <p>WARNING! Falling Hazard. Make sure hinged railing is pinned.</p>

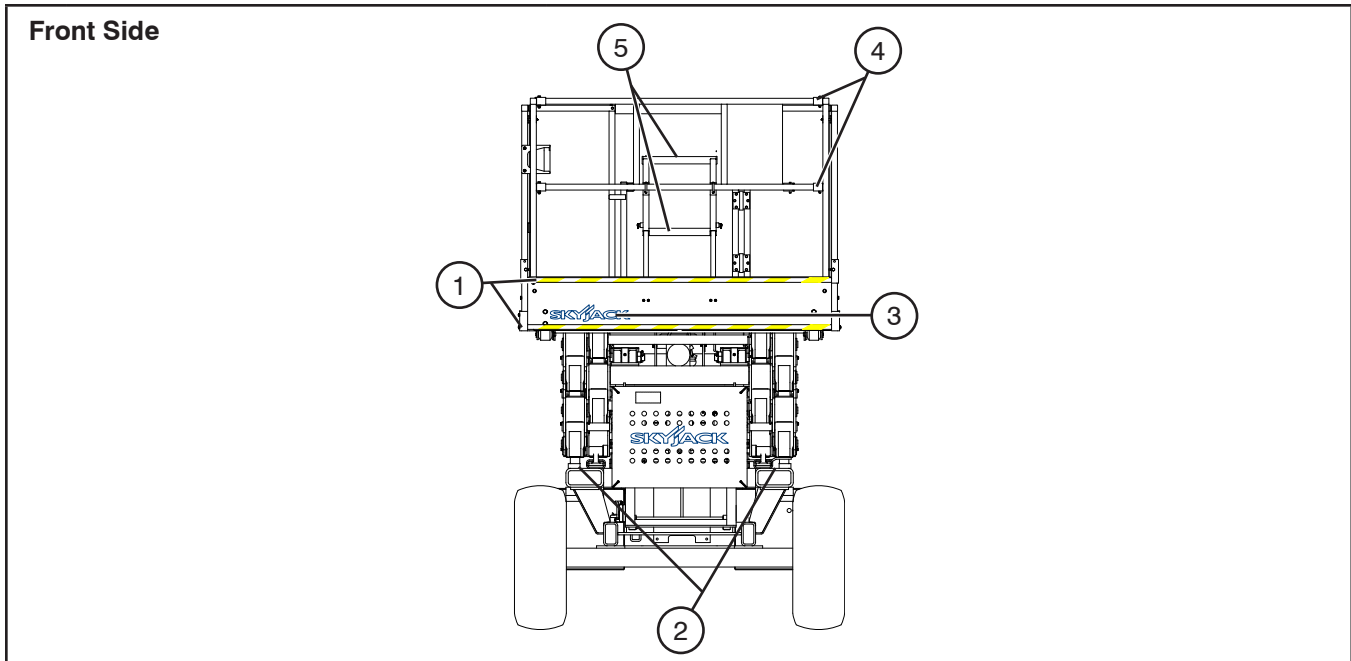





No.	Label Pictorial	Description
1	 <p>DANGER EXPLOSIVE FUMES! NO SMOKING ON OPEN FLAMES! USE EXTREME CAUTION WHEN • REFUELING GASOLINE TANKS • REFUELING DIESEL TANKS • CHANGING PROPANE TANKS WIPE UP ANY SPILLED FUEL</p>	<p>Danger - Explosive Fumes</p> <p>Danger - Explosive Fumes. Do not smoke while refueling aerial platform.</p>
2	 <p>Diesel, EN 590, DIN 51 628</p>	<p>Diesel</p> <p>Use diesel fuel only.</p>
3		<p>No Smoking</p> <p>Do not smoke near this location.</p>
4	 <p>ATF DEXRON III (SAE 15W-40)</p>	<p>Hydraulic Oil ATF Dexron III</p> <p>Replace hydraulic fluid with ATF Dexron III only.</p>
		<p>Hydraulic Oil Level</p> <p>Indicates minimum/maximum oil level.</p>

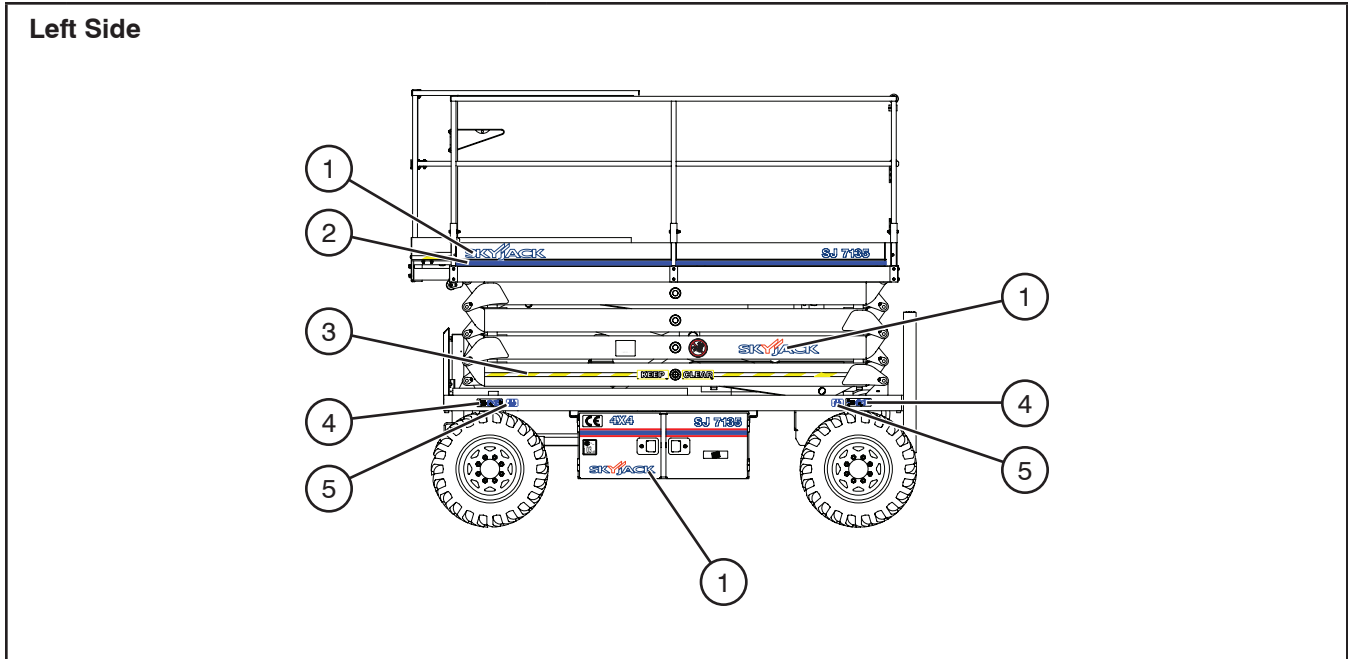



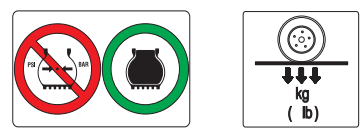

No.	Label Pictorial	Description
1		<p>Caution Tape Stripe</p> <p>Caution stripe</p>
2		<p>Lift and Tie Down Points</p> <p>Only use these points for lifting or tying down.</p>
3		<p>Skyjack Logo</p> <p>Large Skyjack logo - blue and red</p>
4		<p>Warning - Falling hazard. Hinge point.</p> <p>WARNING! Falling Hazard. Make sure hinged railing is pinned.</p>
5		<p>No Step</p> <p>WARNING! Do not step in this location.</p>

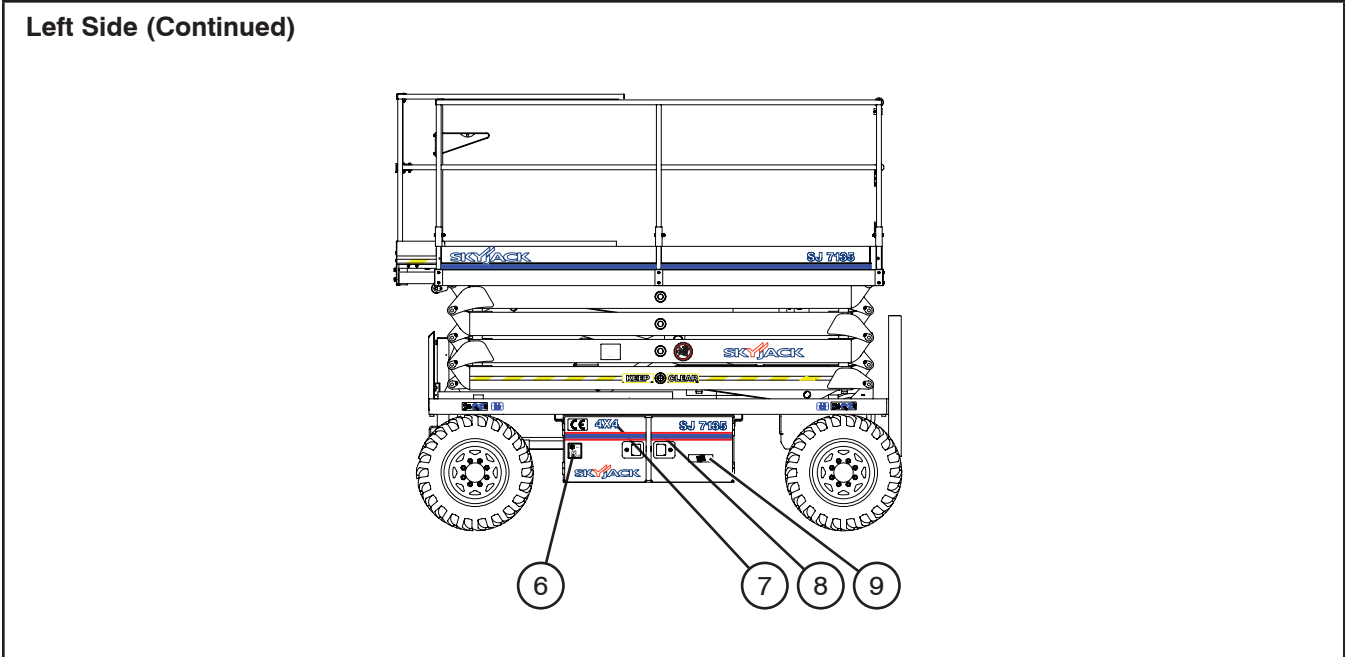





No.	Label Pictorial	Description
1		<p>Skyjack Logo Large Skyjack logo - blue and red</p>
2		<p>Tape Blue/White Skyjack pinstripe</p>
3		<p>Caution Tape Stripe Caution stripe</p>
4		<p>Wheel Specifications Refer to manual for wheel type, offset, pressure and torque.</p>
5		<p>Foam-filled & Wheel load* Indicate foam-filled tire and rated wheel load. *Wheel load will vary over different aerial platforms.</p>

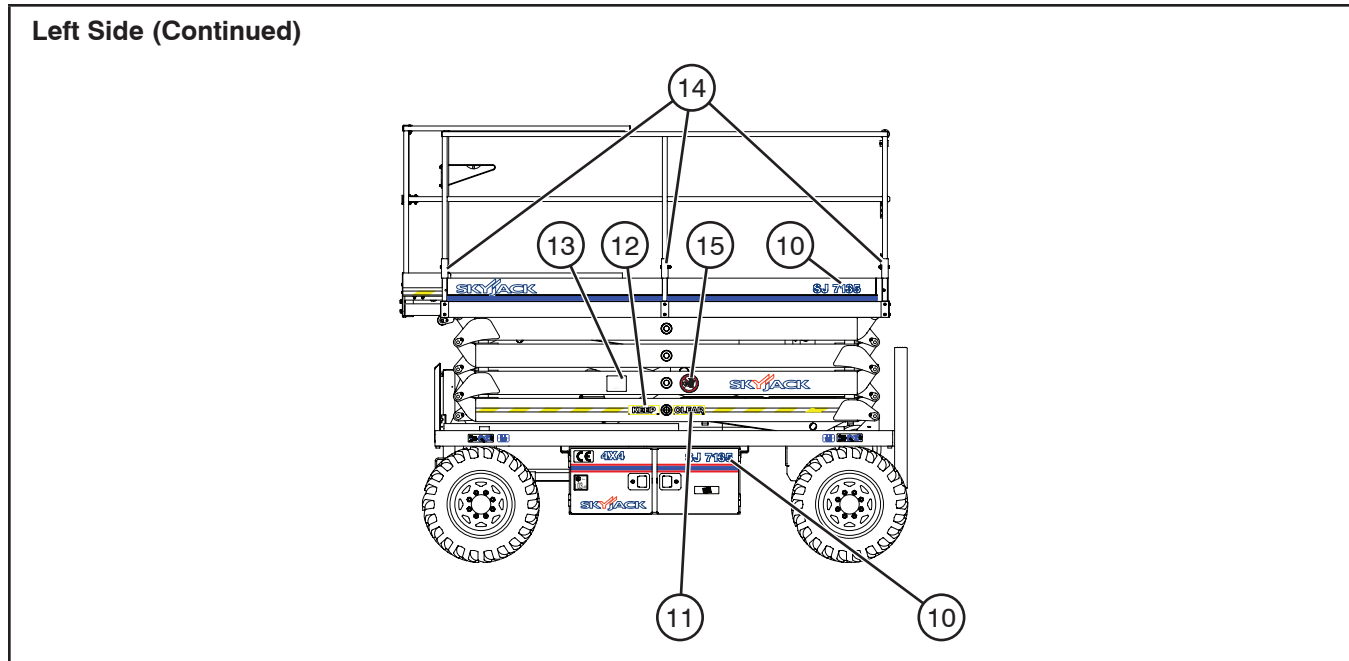



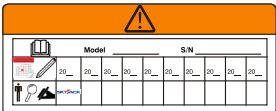

No.	Label Pictorial	Description
6		<p>Sound Power Level</p> <p>Guaranteed maximum sound power level</p>
7		<p>4x4</p> <p>Product identifier - 4 wheel drive</p>
8		<p>Tape - Red/Blue/Red</p> <p>Skyjack pinstripe</p>
9		<p>Manual Storage Box</p> <p>Indicates location of operating manual</p>

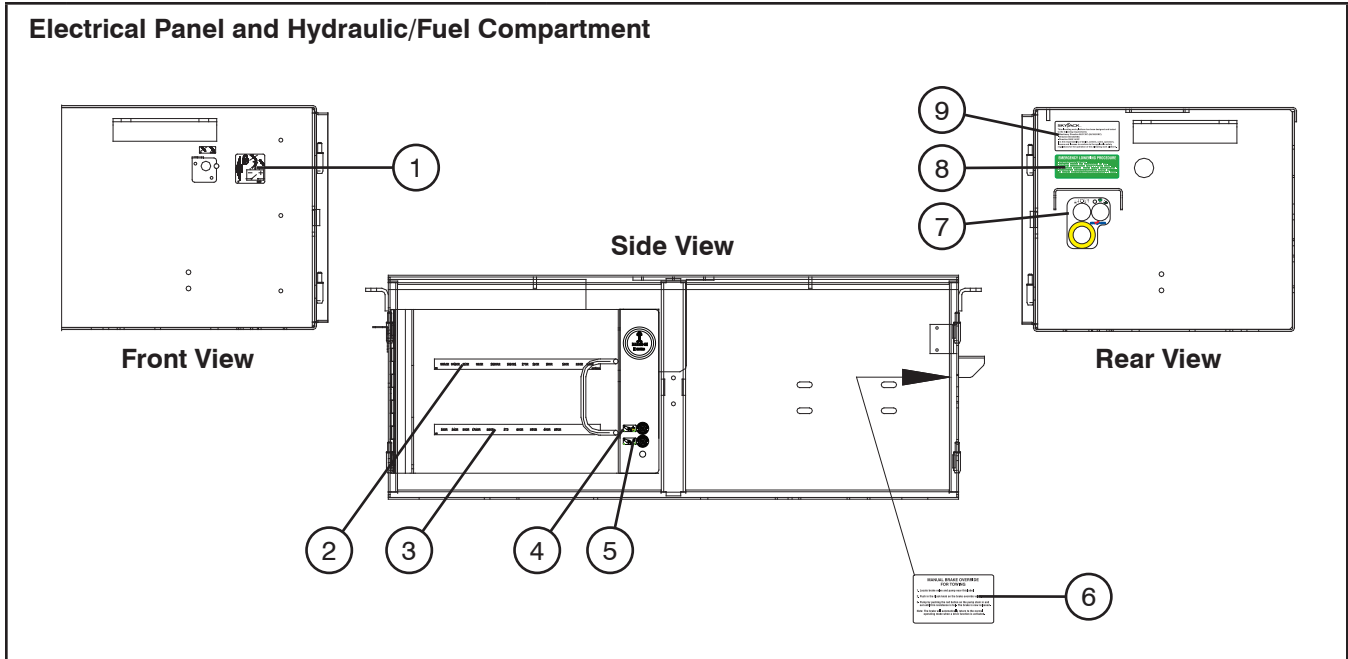

No.	Label Pictorial	Description
10		<p>Model Number*</p> <p>Product Identifier *Model number will vary, may not be as shown.</p>
11		<p>“Clear”</p> <p>Keep clear.</p>
12		<p>“Keep”</p> <p>Keep clear.</p>
13		<p>Annual Inspection</p> <p>Ensure that aerial platform has received annual inspection prior to operation.</p>
14		<p>Warning - Falling hazard. Hinge point.</p> <p>WARNING! Falling Hazard. Make sure hinged railing is pinned.</p>
15		<p>“Keep Clear”</p> <p>Keep clear.</p>

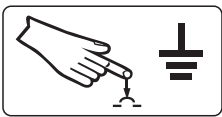



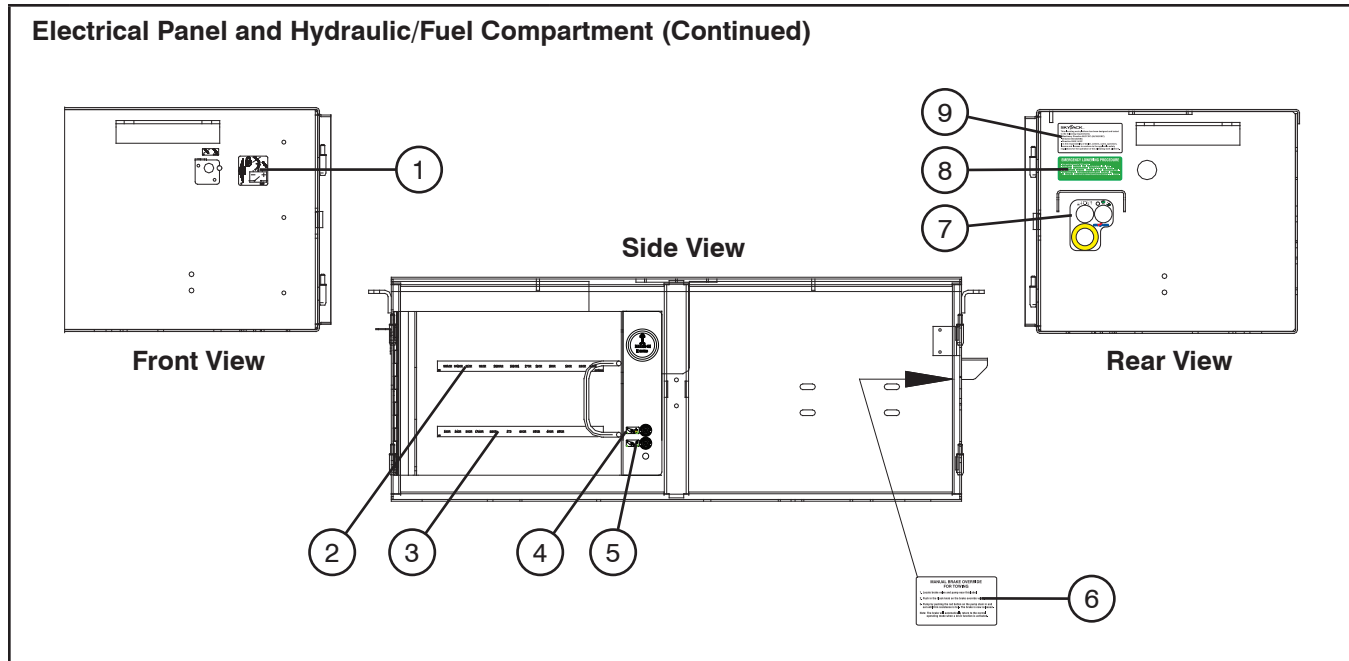

No.	Label Pictorial	Description
1		<p>Main Power Disconnect</p> <p>Main power disconnect lever</p>
2		<p>Relay Names - Upper (Model 71xx)*</p> <p>Relay names for Model 71xx electrical panel (upper bank) *Note: Relay names will vary with differing units</p>
3		<p>Relay Names - Lower (Model 71xx)*</p> <p>Relay names for Model 71xx electrical panel (lower bank) *Note: Relay names will vary with differing units</p>
4		<p>Ground Circuit Breaker</p> <p>Push to reset ground circuit breaker.</p>
5		<p>Power Circuit Breaker</p> <p>Push to reset power circuit breaker.</p>

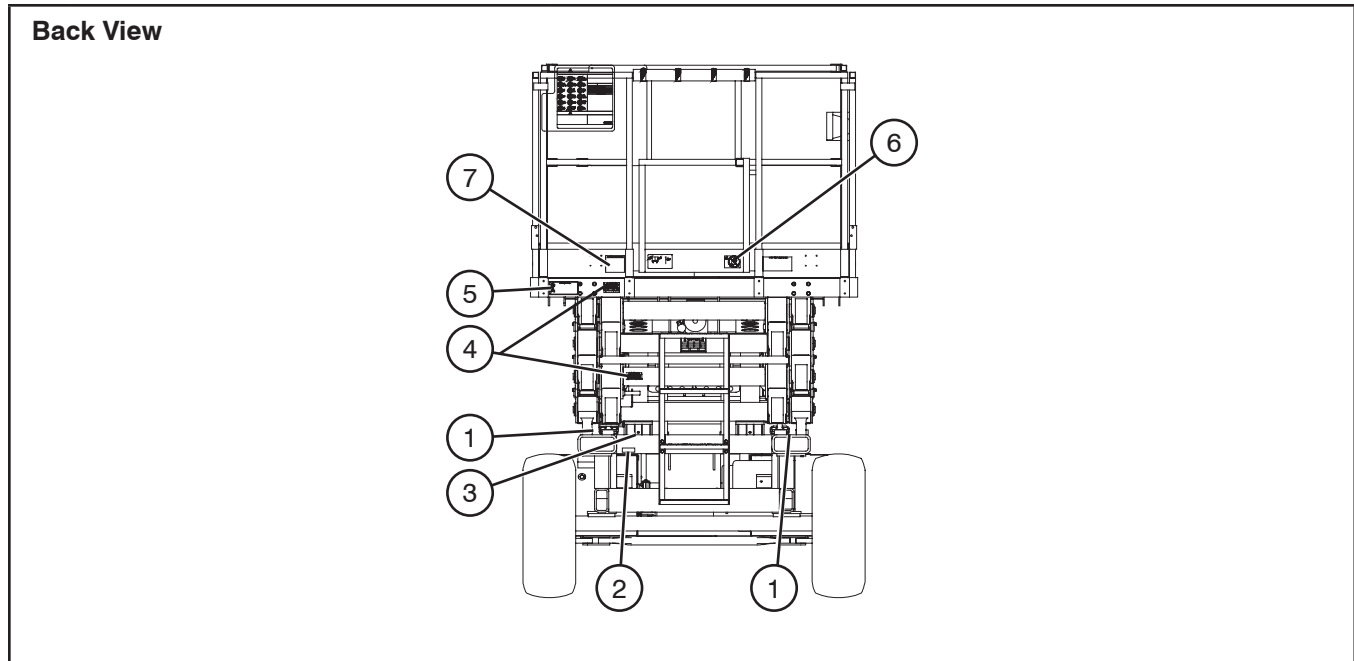

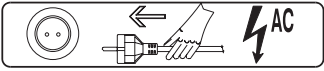
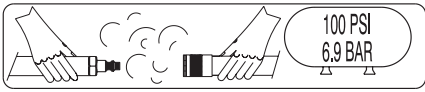

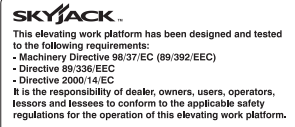
No.	Label Pictorial	Description
6		<p>Winching/Towing/Pushing Procedure</p> <p>Winching/towing/pushing procedure. Ensure brake is released and free-wheeling valve is open before moving the unit manually.</p>
7		<p>Base Controls</p> <p>Select “ ↓” to lower or “ ↑” raise platform.</p> <p>Select “ ” platform to enable platform controls, “○” off to disable controls or “ ” base to enable base control console.</p> <p>Push “ ” to disable controls.</p>
8		<p>Emergency Lowering Procedure</p> <p>In case of emergency, follow lift procedure outlined in label to lower the platform.</p>
9		<p>Standards Compliance</p> <p>Indicates standards to which aerial platform complies.</p>



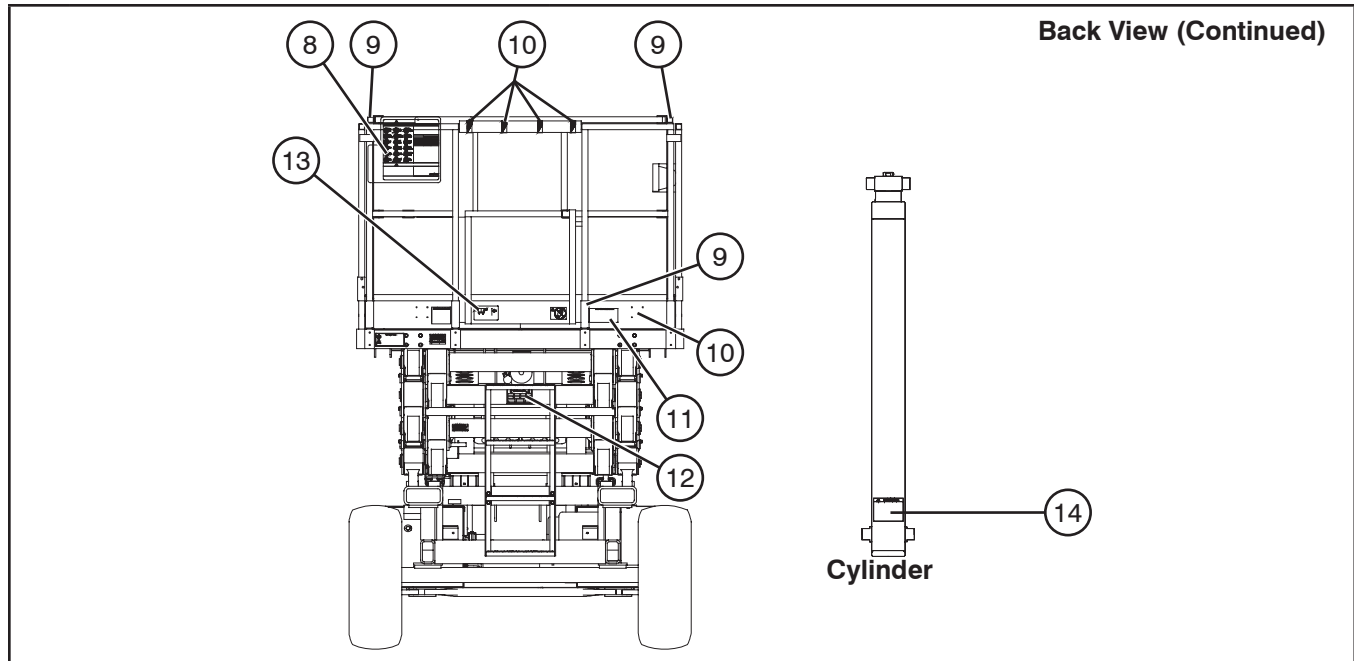



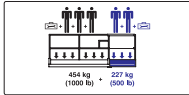
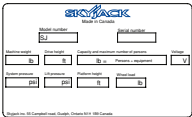
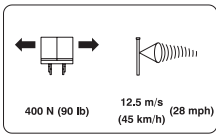
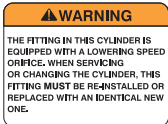

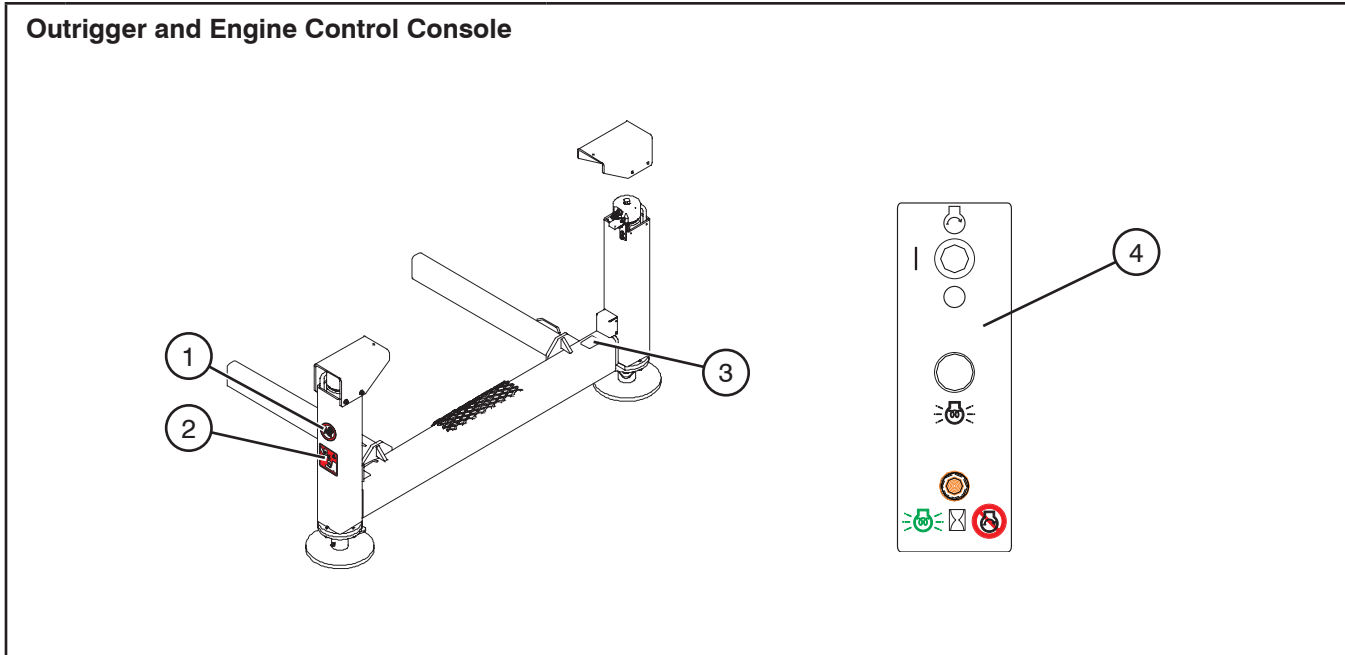

No.	Label Pictorial	Description
1		<p>Lift and Tie Down Points</p> <p>Only use these points for lifting or tying down.</p>
2		<p>Connect Platform A/C Supply</p> <p>Connect A/C power supply here for platform accessory outlet.</p>
3		<p>Connect Air Supply</p> <p>Connect platform air supply here.</p>
4		<p>Warning - Do Not Alter</p> <p>Aerial platform altering warning</p>
5		<p>Standards Compliance</p> <p>Indicates standards to which the aerial platform complies.</p>
6		<p>No Jewelry</p> <p>Caution. Do not wear jewelry.</p>
7		<p>Operator Checklist</p> <p>Operator checklist. Perform check prior to use.</p>



No.	Label Pictorial	Description
8		<p>Hazard Identification</p> <p>Read and understand the outlined risks associated with this aerial platform prior to operation.</p>
9		<p>Warning - Falling hazard. Hinge point.</p> <p>WARNING! Falling Hazard. Make sure hinged railing is pinned.</p>
10		<p>Caution Tape Stripe</p> <p>Caution Strip</p>
11		<p>Platform Capacity*</p> <p>Rated work load in each configuration is as shown. *Platform capacity varies over different aerial platforms.</p>
12		<p>Serial Plate*</p> <p>Product identification and specifications *Serial plate will vary over different aerial platforms.</p>
13		<p>Horizontal Load Rating*</p> <p>Apply no more than the indicated side load. Operate below indicated wind speed only. *Rating will change over varying units.</p>
14		<p>Orifice Installed</p> <p>Orifice installation warning</p>



No.	Label Pictorial	Description
1		<p>Keep Clear Keep clear.</p>
2		<p>Crushing Hazard Danger - crushing hazard</p>
3		<p>Warning - Do Not Alter Aerial platform altering warning</p>
4		<p>Engine Control</p> <p>Select “” to start, “” run or “” stop engine.</p> <p>Select “” to energize glow plugs.</p> <p>Do not start engine “”. Red lamp “” illuminates until the glow plugs have completed the timed heating cycle. When the lamp goes out, the engine is ready to be started.</p>

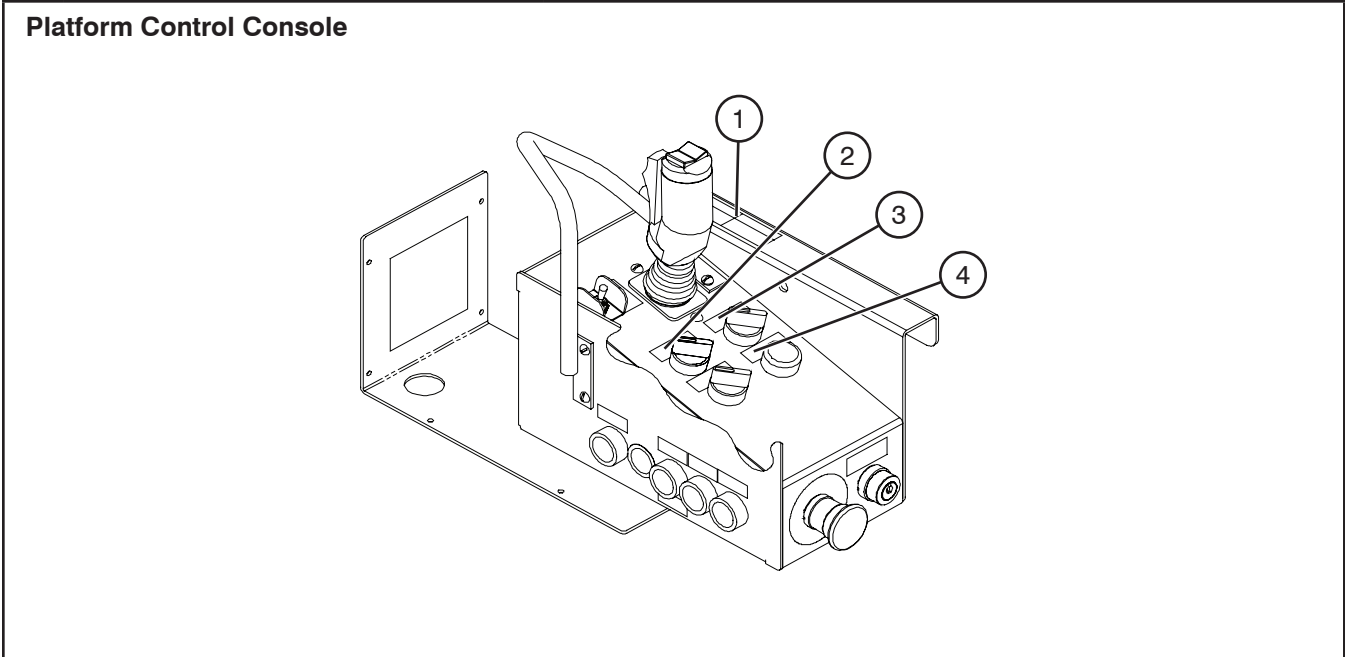



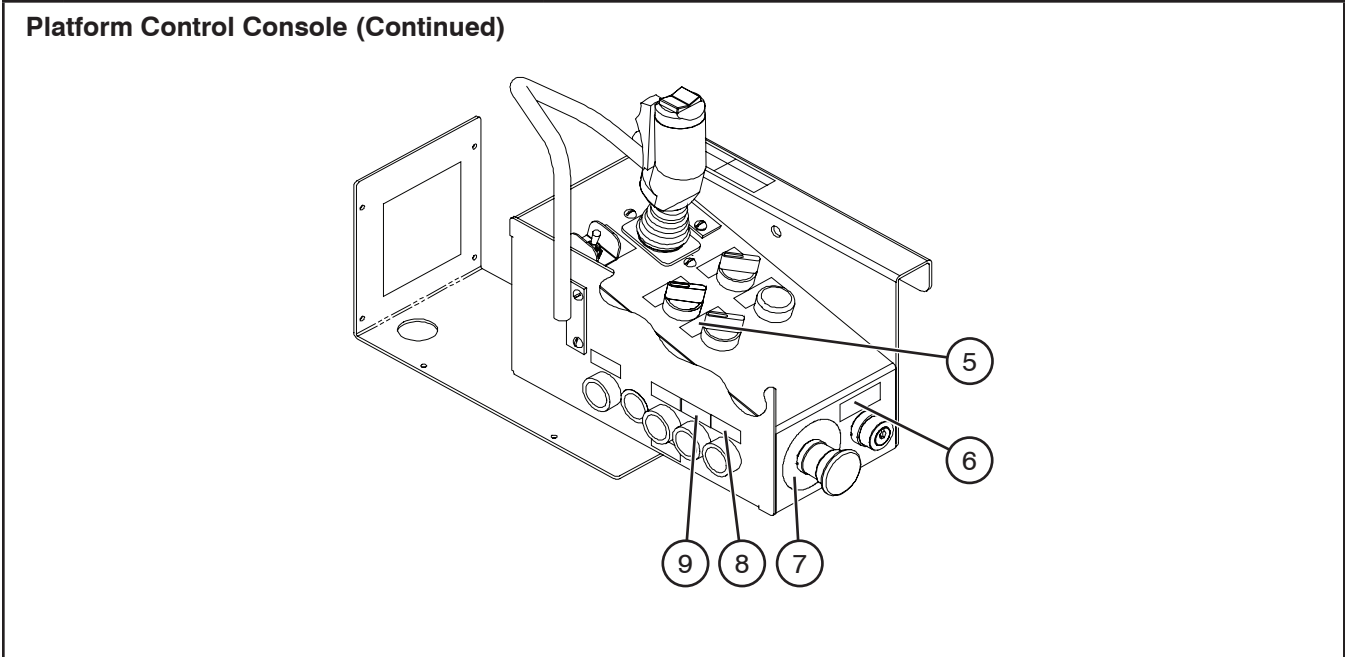

No.	Label Pictorial	Description
1		<p>Controller Operation</p> <p>Squeeze “” trigger to enable controller.</p> <p>Operate “” rocker switch to steer.</p> <p>Move controller forward “” to drive forward or backward “” to drive reverse..</p>
2		<p>Low/High Speed Range</p> <p>Select “” for low speed (high torque) or “” high speed (low torque).</p>
3		<p>Low/High Throttle</p> <p>Select “” low or “” high engine speeds.</p>
4		<p>Power On/Overload Indicator</p> <p>Continuous illumination indicates upper control availability. Flashing indicates aerial platform is overloaded.</p>

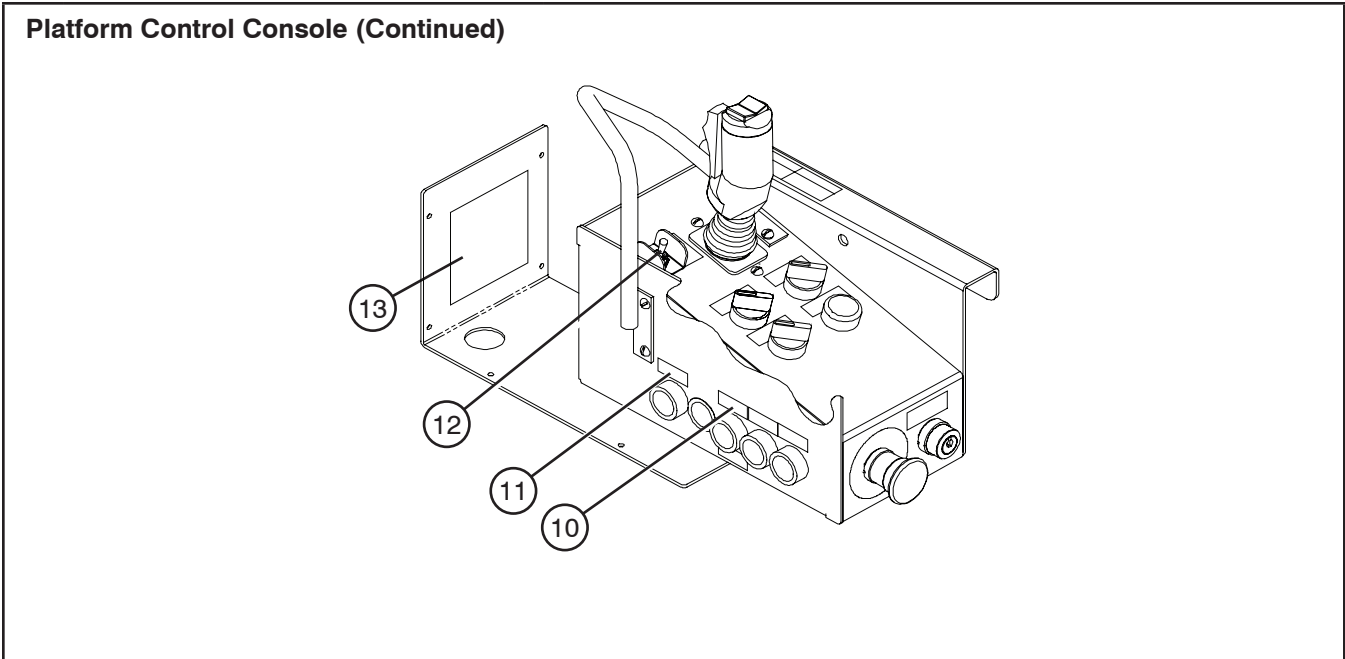





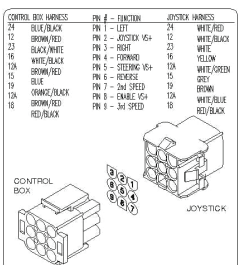

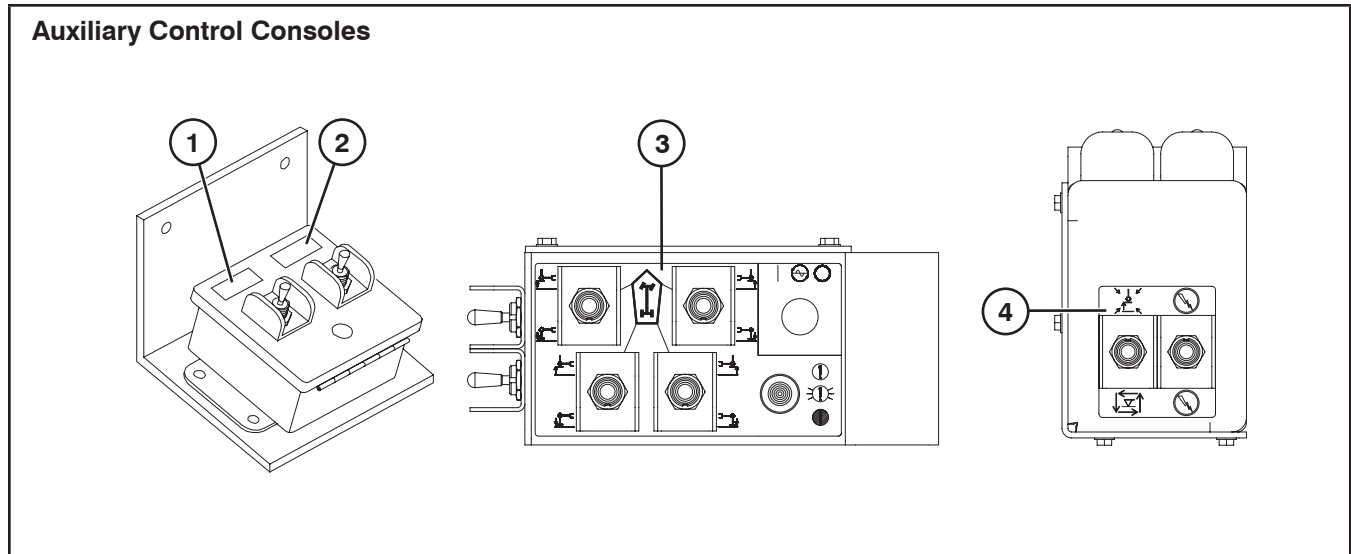

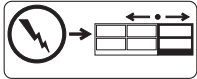
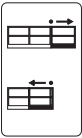

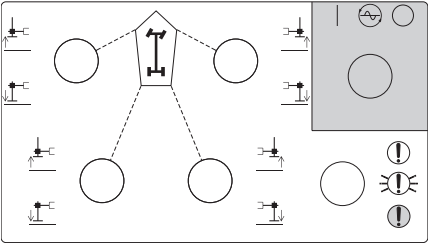



No.	Label Pictorial	Description
5		<p>Raise/Off/Lower Platform</p> <p>Select “” to raise the platform, “○” to turn power off or “” to lower the platform.</p>
6		<p>Lift/Off/Drive</p> <p>Select “” to enable lift, “○” off or “” drive mode.</p>
7		<p>Emergency Stop</p> <p>Push to disable controls</p>
8		<p>Lift Enable</p> <p>Select to enable lift mode.</p>
9		<p>Start Engine</p> <p>Select to start engine.</p>

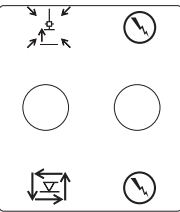

No.	Label Pictorial	Description
10		<p>Glow Plug</p> <p>Select to activate glow plugs.</p>
11		<p>Horn</p> <p>Select to sound horn.</p>
12		<p>Low/High Torque</p> <p>Select “” low speed (high torque) or “” high speed (low torque).</p>
13		<p>Controller Connector Pinout</p> <p>Controller connector pinout.</p>



No.	Label Pictorial	Description
1		<p>Powered Extension Platform Enable</p> <p>Select to enable powered extension platform controls.</p>
2		<p>Powered Extension Platform Extend/Retract</p> <p>Select “” to extend or “” to retract powered extension platform.</p>
3		<p>Outrigger Controls with Generator</p> <p>Select “” to retract or “” to extend for each outrigger.</p> <p>Select “” to enable or “” disable generator.</p> <p>Indicates leveling system status:</p> <ul style="list-style-type: none">  Off: The outriggers are fully retracted.  Flashing Rapidly: The outriggers are extending or retracting.  Flashing: Not all outrigger legs have firm ground contact or aerial platform is not level.  On: The outriggers are extended and the platform is level.
4		<p>Automatic Outrigger Controls</p> <p>Select “” to retract all outriggers or “” to extend all outriggers with automatic leveling.</p> <p>Select “” to enable manual or automatic outrigger controls.</p>



Reliable lift solutions by people who care.

www.skyjack.com